



PASSENGER AND AIRPORT DATA INTERCHANGE STANDARDS

**XML IMPLEMENTATION GUIDE
PNR DATA PUSHED TO STATES
OR OTHER AUTHORITIES
PNRGOV MESSAGE**

Version 16.1

(subject to approval and publication by the WCO API Contact Committee)

NOTICE

DISCLAIMER. The information contained in this publication is subject to constant review in the light of changing government requirements and regulations. No subscriber or other reader should act on the basis of any such information without referring to applicable laws and regulations and/or without taking appropriate professional advice. Although every effort has been made to ensure accuracy, the International Air Transport Association shall not be held responsible for loss or damage caused by errors, omissions, misprints or misinterpretation of the contents hereof. Furthermore, the International Air Transport Association expressly disclaims all and any liability to any person, whether a purchaser of this publication or not, in respect of anything done or omitted, and the consequences of anything done or omitted, by any such person in reliance on the contents of this publication.

No part of the Passenger and Airport Data Interchange Standards XML Implementation Guide – for PNRGOV Message Document may be reproduced, recast, reformatted or transmitted in any form by any means, electronic or mechanical, including photocopying, recording or any information storage and retrieval system, without the prior written permission from:

Managing Director,
IATA Distribution and Financial Services
International Air Transport Association
800 Place Victoria
P.O. Box 113
Montreal, Quebec
Canada, H4Z 1M1



- 1. INTRODUCTION 1**
 - 1.1 PNRGOV MESSAGE VERSION RELEASE 1
 - 1.1.1 *WHAT MESSAGE VERSION IS SUPPORTED BY WHICH IMPLEMENTATION GUIDE* 1
 - 1.1.2 *ERRATA* 1
 - 1.2 DOCUMENT STRUCTURE..... 2
 - 1.3 HOW TO USE THIS DOCUMENT 2
 - 1.4 GUIDELINES AND RULES..... 2
 - 1.5 CODE SETS 3
 - 1.6 REFERENCES 3
- 2 MESSAGE RELATIONSHIP 4**
 - 2.1 PNRGOV..... 4
- 3 SCHEMA STRUCTURE 4**
 - 3.1 MESSAGE SEGMENT DESCRIPTIONS (PNRGOV) 4
 - 3.2 PUSH OF PNR DATA TO STATE - (IATA_PNRGOV_NOTIFRQ) 6
- 4 MESSAGE DEFINITION..... 7**
 - 4.1 IATA_PNRGOV_NOTIFRQ..... 8
 - 4.2 ORIGINATOR - SPECIFIES THE SENDER OF THE MESSAGE..... 10
 - 4.3 FLIGHTLEG - THE FLIGHT FOR WHICH PASSENGER DATA IS BEING SENT 11
 - 4.4 PNRs..... 13
 - 4.5 PNR – REPEATS FOR EACH PASSENGER RECORD 14
 - 4.6 BOOKINGREFID – THE RECORD LOCATOR FOR THIS PASSENGER RECORD..... 15
 - 4.7 SSR – SPECIAL SERVICE DATA THAT APPLIES TO ALL PASSENGER/FLIGHTS 17
 - 4.8 OSI – OTHER SERVICE INFORMATION FOR ALL PASSENGERS/FLIGHTS..... 19
 - 4.9 POS – ORIGINATION OF THE BOOKING 21
 - 4.10 CONTACTINFO – CONTACT INFORMATION (PHONE, ADDRESS, EMAIL) 23
 - 4.11 PREPAIDBAG – PREPAID BAGGAGE AMOUNTS 25
 - 4.12 PASSENGER – PASSENGER SURNAME, GIVEN NAME, PTC CODE (REPEATS FOR EACH PASSENGER) 26
 - 4.13 CUSTLOYALTY – FREQUENT TRAVELER NUMBERS FOR THE PASSENGER 29
 - 4.14 OSI – OTHER SERVICE INFORMATION FOR A PASSENGER 30
 - 4.15 EXCESSBAGGAGE – EXCESS BAGGAGE INFORMATION FOR ALL PASSENGERS/FLIGHTS 32
 - 4.16 FAREINFO – FARE AND UNSTRUCTURED FARE CALCULATION INFORMATION 34
 - 4.17 SSR – SPECIAL SERVICE DATA THAT APPLIES TO THE PASSENGER FOR ALL THE FLIGHTS..... 36
 - 4.18 CONTACTINFO – EMERGENCY CONTACT INFORMATION..... 38
 - 4.19 TICKETDOCUMENT – TICKET DOCUMENT NUMBER, DATE AND PLACE OF ISSUE AND REASONS FOR ISSUANCE CODE AND SUBCODE (EMDs)..... 40
 - 4.20 TOTALFARE – TOTAL FARE AMOUNT 42
 - 4.21 PRICEINFO – PRICING DATE, TIME, ISO COUNTRY CODE , AND LOCATION..... 43
 - 4.22 TAXES/TAX – TAX AMOUNT FOR THE TICKET 44
 - 4.23 PAYMENTINFO – FORM OF PAYMENT, PAYMENT AMOUNT, CREDIT CARD NUMBER AND EXPIRATION DATE AND SPONSOR INFORMATION..... 46
 - 4.24 DOC_SSR – FORMATTED DOCA, DOCO, AND DOCS SSR INFORMATION..... 47
 - 4.25 DOCA – FORMATTED PASSENGER ADDRESS SSR INFORMATION..... 49
 - 4.26 DOCO – FORMATTED PASSENGER OTHER SUPPLEMENTARY SSR INFORMATION..... 50
 - 4.27 DOCS - FORMATTED TRAVEL DOCUMENT SSR INFORMATION 51
 - 4.28 FLIGHT – A FLIGHT IN THE ITINERARY FOR THE PASSENGER 53
 - 4.29 SSR – SPECIAL SERVICE REQUESTS THAT APPLY TO THIS FLIGHT..... 55
 - 4.30 BOOKINGREFID – PASSENGER RECORD LOCATOR SPECIFIC TO THIS FLIGHT..... 57
 - 4.31 OSI – OTHER SERVICE INFORMATION FOR THIS FLIGHT..... 59
 - 4.32 CHECKININFO – THE CHECK-IN TIME AND AGENT INFORMATION THAT CHECKED-IN THE PASSENGER 61
 - 4.33 PASSENGER – THE CHECKED-IN NAME 63
 - 4.34 SEATNUMBER – ACTUAL SEAT NUMBER 64
 - 4.35 CHECKEDBAG – CHECKED BAG INFORMATION 65
 - 4.36 SPLITPNR – THE NUMBER OF PASSENGERS SPLIT TO/FROM A PASSENGER RECORD AND THE SPLIT RECORD LOCATORS 67
 - 4.37 OTHERTRAVELSEGMENT – NON- AIR SEGMENT INFORMATION (CAR, HOTEL) 68
 - 4.38 HOTELINFO – HOTEL SEGMENT DATA 70



4.39	CARINFO – CAR SEGMENT INFORMATION.....	71
4.40	STRUCTUREDPNR_HISTORY – STRUCTURED PNR HISTORY (REPEATS FOR EACH OCCURRENCE OF A HISTORY CREDIT). <i>NOTE: INCLUDES THE ORIGINATOR OF THE CHANGE, AGENT ID, AND A TIME STAMP.</i>	72
4.41	ITEM – ONE LINE IN A HISTORY CREDIT	74
4.42	FLIGHT – HISTORY FLIGHT INFORMATION	75
4.43	PASSENGER – HISTORY PASSENGER NAME CHANGES	77
4.44	SSR – HISTORY SPECIAL SERVICE REQUIREMENT CHANGES	78
4.45	OSI – HISTORY OTHER SERVICE INFORMATION CHANGES	80
4.46	SEAT – HISTORY SEAT CHANGES	82
4.47	BAG – HISTORY BAGGAGE CHANGES.....	84
4.48	DOC_SSR – HISTORY FORMATTED SSR CHANGES (DOCA, DOCO, DOCS).....	85
4.49	DOCA – HISTORY FORMATTED PASSENGER ADDRESS SSR CHANGES.....	87
4.50	DOCO – HISTORY FORMATTED PASSENGER OTHER SUPPLEMENTARY INFORMATION SSR CHANGES.....	88
4.51	DOCS – HISTORY FORMATTED PASSENGER TRAVEL DOCUMENT SSR CHANGES.....	89
4.52	OTHERTRAVELSEGMENT – NON- AIR SEGMENT INFORMATION (CAR, HOTEL) CHANGES	91
4.53	HOTELINFO – HOTEL SEGMENT DATA	93
4.54	CARINFO – CAR SEGMENT INFORMATION.....	94
4.55	UNSTRUCTUREDPNR_HISTORY – UNFORMATTED HISTORY INFORMATION	95
5	FULL MESSAGE EXAMPLE.....	96

1. INTRODUCTION

The purpose of this document is to describe the recommended usage of the Passenger and Airport Data Interchange Standards PNRGOV XML (Extensible Mark-up Language) Message Standards. These messages are intended to facilitate the exchange of data relevant to government requirements on PNR data and Airlines reservation systems.

This document was developed, and will be maintained, by the IATA/A4A PNRGOV Working Group in coordination with the Data Dictionary and Schema Coordination Committee (DDSCC) of IATA Passenger and Airport Data Interchange Standards Board.

This will be a living document and will be updated as necessary. If there are any changes to the message structure, the change process defined in the PNRGOV Principles Document shall be followed.

1.1 PNRGOV MESSAGE VERSION RELEASE

Version control will be handled in the following manner:

- Message structure change requires a new version of the message and new version of the Implementation Guide.
- Changes in the text of the Implementation Guide other than message structure changes may also trigger new release of the Implementation Guide.
- Minor changes can be kept in the Errata document attached to a specific release of the Implementation Guide and eventually incorporated into the next new release and new version of the same.
- Any text pending formal approval by the WCO API Contact Committee and/or the PADIS Board will be shaded in grey.

1.1.1 WHAT MESSAGE VERSION IS SUPPORTED BY WHICH IMPLEMENTATION GUIDE

This table lists all current PNRGOV XML messages and shows in which PNRGOV Implementation Guide document release a message was modified from its previous publication. A bold version release shows the first publication of that message or guide.

Implementation guide	13.1	14.1	15.1	16.1											
IATA_PNRGOV_NotifRQ	2.000	2.001	2.002	2.003											

1.1.2 ERRATA

An ERRATA sheet will be maintained for each release and will be stored on the IATA website along with the corresponding Implementation Guide.

- Each entry in the Errata sheet will include a sequence number, date included in ERRATA, Implementation Guide paragraph reference, current text and/or problems description for charts, required change in text and/or change description for charts, reason for change, and who submitted the ERRATA item. .
- Once an entry is made in Errata sheet, the PNRGOV group will receive a notification.
- The Errata sheet is intended only for minor corrections. Issues which require debate by the group must be submitted, together with a proposed solution, as formal agenda items to a PNRGOV Working Group meeting.
- Once changes are approved by the PNRGOV Working Group, the group will follow the change process identified in the Principles document to notify WCO of changes being proposed for the PNRGOV implementation guide.

1.2 DOCUMENT STRUCTURE

This document contains the following seven sections:

Introduction

Contains an overview and guidelines for use of the document.

Message Relationships

Describes the relationship between push (IATA_PNRGOV_NotifRQ) message and the expected response message (IATA_AcknowledgementRS).

Message Schema Structure

Shows in diagrammatic format each approved PADIS PNRGOV message. The diagrams show the construction of the message and the data elements used. The hierarchy of the schema data elements are labelled from the flight level to the passenger level.

Data Elements and Attributes

Lists in order from top-down all data elements that are part of the message schema contained in this document. For each element there will be a list of possible attributes used to construct the element and an indication of how these elements are commonly used. To cater for different business requirements, there may be multiple definitions of the same data element

Examples

For every business function listed there will be at least one example of the data to be transmitted.

States' Legal Requirements

IATA maintains a copy of the legislation on their API-PNR World Tracker extranet site. Use the following link to access this information:

Link for already registered users:

<https://extranet2.iata.org/sites/facilitation/Lists/API%20World%20Tracker/By%20Country.aspx>

Link to register for access to the FAL extranet site containing the API-PNR World Tracker:

<http://www2.iata.org/registration/getemailpage.aspx?siteurl=facilitation>

Appendices

As necessary, appendices will be added to the Implementation Guide.

Appendix A – xxx

Appendix B – xxx

1.3 HOW TO USE THIS DOCUMENT

The PNRGOV message is currently the only XML Message documented in this Implementation guide. It is anticipated that the XML ACKRES and GOVREQ messages will also be included in this Implementation Guide at a future date.

This guide contains a complete description of the Message Schema, elements and attributes with notes and examples.

1.4 GUIDELINES AND RULES

For all implementation guide additions and updates, the following rules apply to the format and contents, including definitions of special notations:

1. Data elements appear for each possible PNR data item.
2. If an 'N/A' appears in the 'Max Occurs' column, it indicates that the element or attribute is not used for this message, as not applicable use has been identified.

3. Where a State's requirements differ for "Conditional" fields from the standard implementation guide, a separate supplemental document will be provided by the State(s) detailing which "Conditional" fields are "Mandatory" for that State. Provisions in paragraphs 1.5.1 and 1.5.2 of the "Principles, Functional and Business Requirements PNRGOV" shall be respected. These differing requirements will not change the structure of the message.
4. The schema structure indicates whether elements and attributes are required or optional. Where a State's requirements differ from the standard implementation guide, a separate supplemental document will be provided by the State(s). This will not change the structure of the message.

If an element/attribute is a coded value, the "Type" column will indicate "IATA_CodeType"

5. In general, dates and times are expressed in local time except where specifically noted; such as where the time will be expressed in Greenwich Mean Time (GMT) or Universal Time Coordinated (UTC). However, due to different systems criteria, the subject of date/times in various fields from various sources (e.g., centralized reservations and DCS for local vs. centralized system) should be addressed in the bilateral discussions between governments/airlines/system providers.
6. The "Type" refers to how the element or attribute is defined (i.e. string, a, an). If an element or attribute has been restricted to a maximum length or a specific length it will also be noted in the "Type" column.
7. The "Comments" column will use consistent wording for the same attribute across the elements if they are used in the same way.
8. Each element is followed by "Notes" (if applicable) and by element examples. However, "Notes" are only included if they are necessary to explain the usage.
9. Each element and message will have examples to show the standard usage as defined by the PADIS group.
10. For the purpose of the PNRGOV documentation all Airlines are referred to as Carriers and all governments are referred to as States.

1.5 CODE SETS

Codes used in codesets are used to define the values for the relevant business item. All codesets utilized in the PNRGOV message are defined in the **PASSENGER AND AIRPORT DATA INTERCHANGE STANDARDS - Codeset Directory**.

If additional codes are required, requests should be submitted to PADIS through the PNRGOV Working Group for approval prior to them being submitted in the PADIS Board vote for inclusion in the standards.

1.6 REFERENCES

The following documents may be used as additional references to the PNRGOV XML Implementation Guide:

- IATA PNRGOV Principles Document
- IATA PADIS EDIFACT and XML Codeset
- IATA Reservations Interline Message Procedures – Passenger (AIRIMP)
- IATA Passenger Services Conference Resolutions Manual (PSCRM)
- IATA Airline Coding Directory

Definitions of common terms used within the airline industry can be found on the IATA website by accessing the IATA website as follows:

1. Go to the home page www.iata.org
2. Do a search on the word "glossary"
3. Download the spreadsheet entitled "[passenger-glossary-of-terms.xls](#)"

2 MESSAGE RELATIONSHIP

This Section describes the possible query and response relationship of the message developed for PNRGOV function. The following convention is used to represent the possible relationships between messages; a solid line (_____) indicates the primary relationship; and a broken line (-----) indicates an optional relationship.

The message diagram depicts the message relationship by showing the query origin in the top box and the response origin in the bottom box.

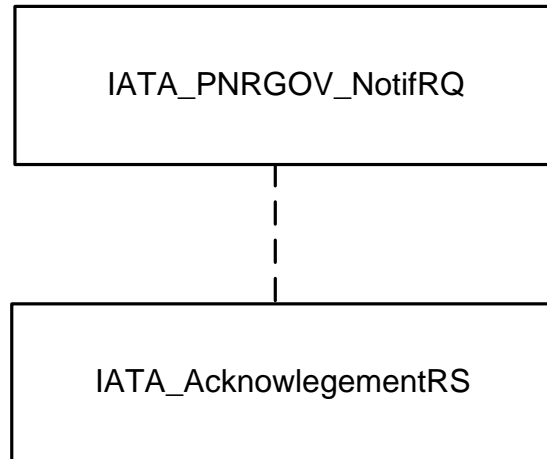

2.1 PNRGOV

The following messages are used by airlines, airline service suppliers and States to exchange PNR related data information.

The IATA_AcknowledgementRS message is only sent where there is a Bilateral Agreement between Carrier and State to do so.

3 SCHEMA STRUCTURE

This document describes the message structure for the approved IATA_PNRGOV_NotifRQ

Within each of the identified elements there may be multiple attributes. While the elements must be in order shown in the schema structure, attributes within an element can be in any order.

3.1 Message Segment Descriptions (PNRGOV)

The following information is intended to provide a high level understanding as to what data is contained in the individual elements. More details are provided in the individual element sections.

Element Order	Brief Description
Originator	Specifies the sender of the message
FlightLeg	The flight for which the passenger data is being sent
PNR	Repeats for each passenger record
BookingRefID	The record locator for this passenger record
SSR	Special service data that applies to all passengers/flights
OSI	Other service information for all passengers/flights
POS	Origination of the booking
ContactInfo	Contact information (phone, address, email)
PrePaidBag	Prepaid baggage amounts
Passenger	Passenger surname, given name, PTC code (repeats for each passenger)
CustLoyalty	Frequent traveller numbers for the passenger
OSI	Other service information for a passenger
ExcessBaggage	Excess baggage information for all passengers/flights
FareInfo	Fare and unstructured fare calculation information
SSR	Special service data that applies to all passengers/flights
ContactInfo	Emergency contact information
TicketDocument	Ticket document number, date and place of issue and reasons for issuance code and sub-code (EMDs)
TotalFare	Total fare amount
PriceInfo	Pricing date, time, ISO, country code and location
Taxes/Tax	Tax amount for the ticket
PaymentInfo	Form of payment, payment amount, credit card number and expiration date
and sponsor information	
DOC_SSR	Formatted DOCA, DOCO and DOCS SSR information
DOCA	Formatted passenger address SSR information
DOCO	Formatted passenger other supplementary SSR information
DOCS	Formatted travel document SSR information
Flight	A flight in the itinerary for the passenger
SSR	Special service requests that apply to this flight
BookingRefID	Passenger record locator specific to this flight
OSI	Other service information for this flight
CheckInInfo	The check-in time and agent information that checked-in the passenger
Passenger	The checked-in name
SeatNumber	The actual seat number
CheckedBag	Checked bag information
SplitPNR	The number of passengers split to/from a passenger record and the split record Locators
OtherTravelSegment	Non-air segment information (car, hotel)
HotelInfo	Hotel segment data
CarInfo	Car segment information
StructuredPNR_History	Structured PNR History (repeats for each occurrence of a history credit) <i>Note:</i> Includes the originator of the change and agent ID and a time stamp
Item	One line in a history credit
Flight	History flight information
Passenger	History passenger name changes
SSR	History special service requirements changes
OSI	History other service information changes
Seat	History seat changes
Bag	History baggage changes
DOC_SSR	History formatted SSR changes (DOCA, DOCO, DOCS)
DOCA	History formatted passenger address SSR changes
DOCO	History formatted passenger other supplementary information SSR changes
DOCS	History formatted passenger travel document SSR changes
UnstructuredPNR_History	Unformatted history information

3.2 Push of PNR DATA to State - (IATA_PNRGOV_NotifRQ)

Function: This message enables airlines to send data relevant to State requirements for passenger data in airline reservation systems.

IATA_PNRGOV_NotifRQ XML Message Structure

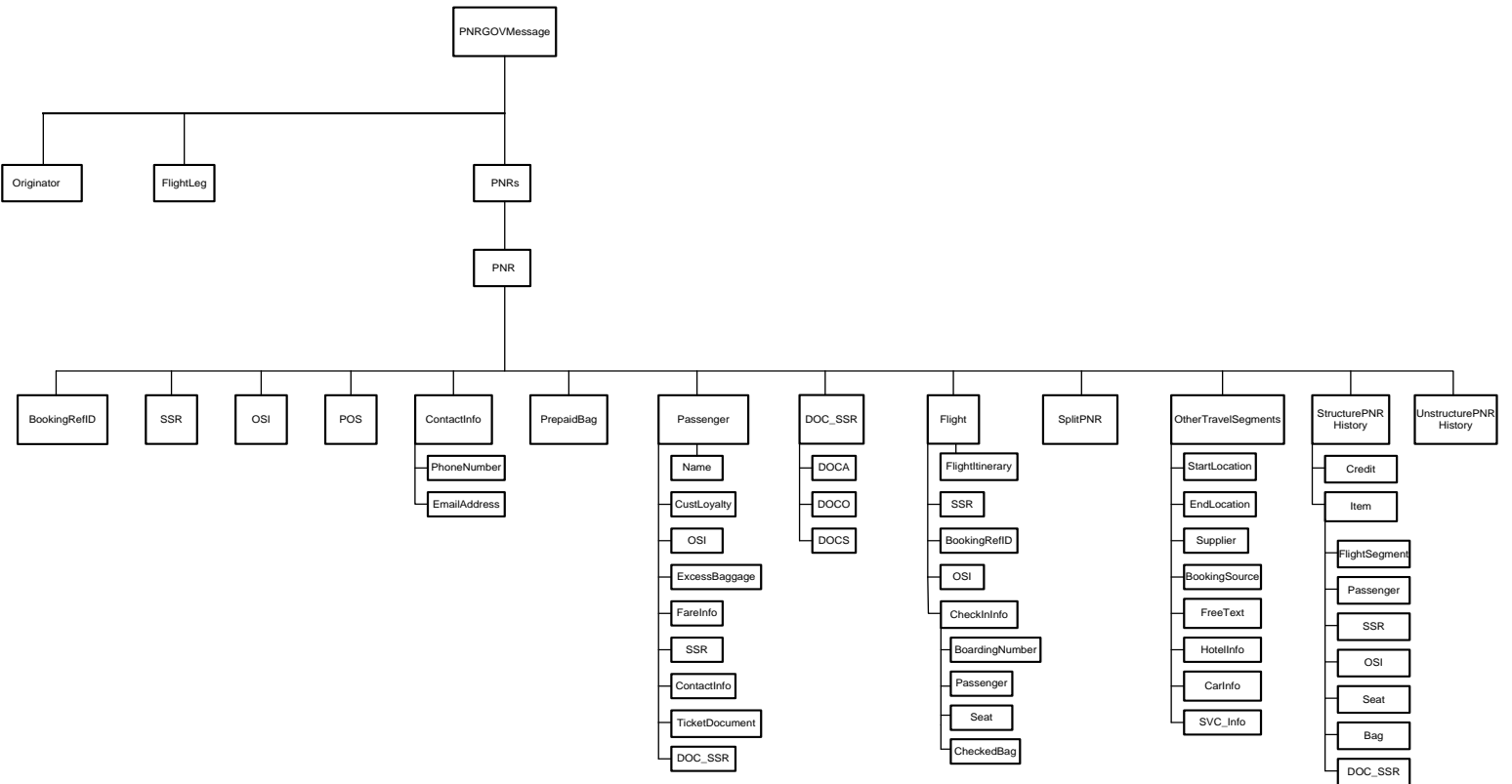

4 MESSAGE DEFINITION

The PNR information available in the PNRGOV message is defined by a set of xml schema files. The remainder of this document will define and explain the contents of the message and all necessary definitions. The explanation will extensively utilize the documentation and drawing capabilities of the Altova® XMLSpy software package. See below for a short explanation of how to read the diagrams.

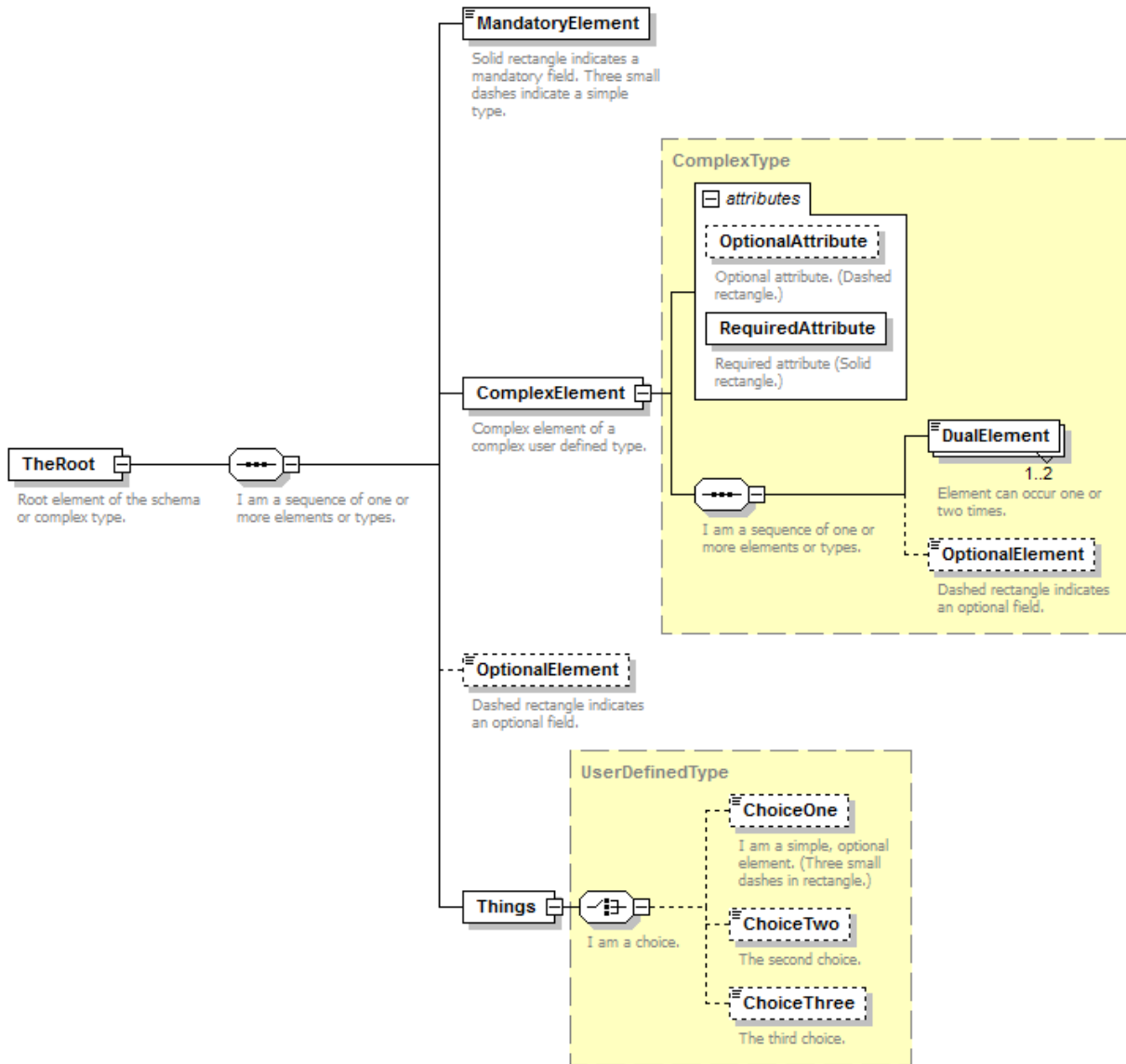

Generated with XMLSpy Schema Editor www.altova.com

Following the diagrams will be a matrix containing mapping of the elements within the diagram to their definitions, counts, code table mapping, common values/formats and a business definition. At the end of each matrix will be samples showing the usage of the elements being described.

4.1 IATA_PNRGOV_NotifRQ

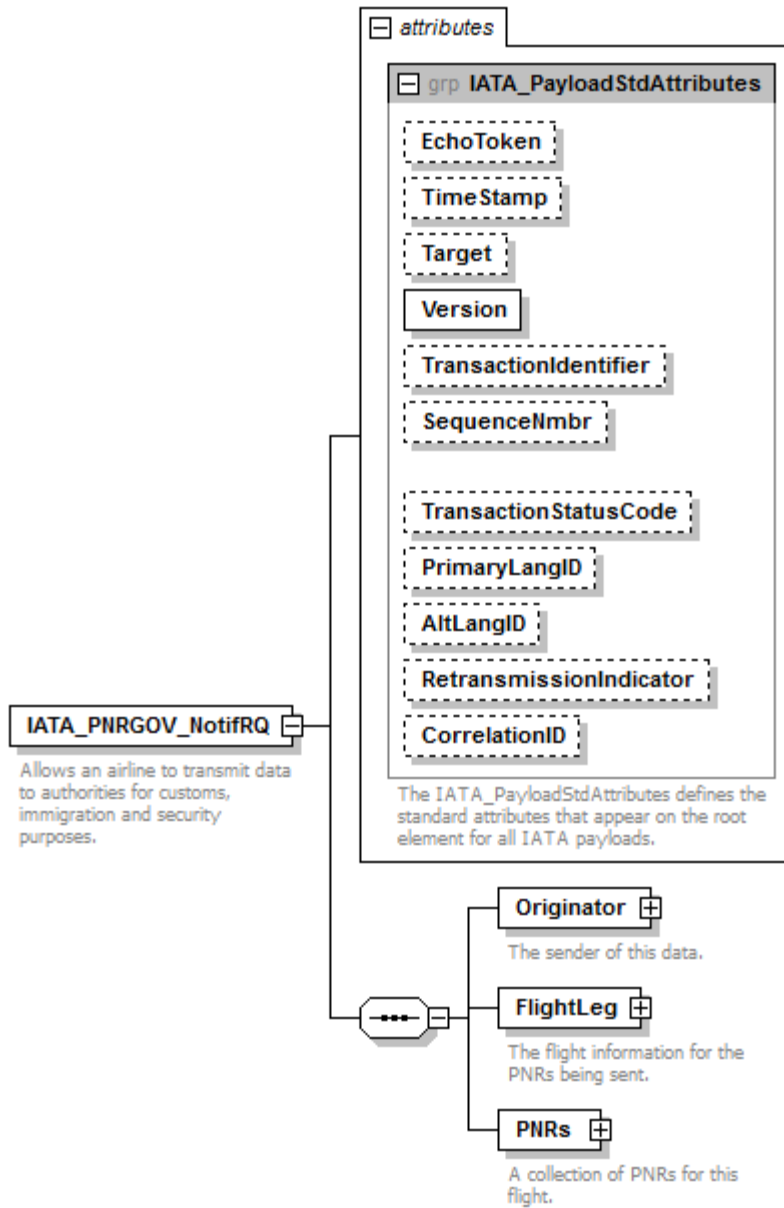

IATA_PNRGOV_NotifRQ

Data Item	Type	Max Occurs	Comments
EchoToken	string	1	A reference for additional message identification.
TimeStamp	YYYY-MM-DDTHH:MM:SS	1	The creation date and time of the message.
Target	Nmtoken	1	Used to specify if request is for the test or production system
Version	decimal	1	The version of the message
TransactionIdentifier	string	1	A unique identifier to relate all messages within a transaction.
SequenceNbr	integer		
TransactionStatusCode	Nmtoken		
PrimaryLangID		N/A	
AltLangID		N/A	
RetransmissionIndicator	boolean		When true, indicates the messages is being re-sent after a failure.
CorrelationID	string		Allows end-to-end correlation of log messages throughout the processing.

Example:

EchoToken="123456" TimeStamp="2013-05-27T07:54:00" Target="Production" Version="1.000"
 TransactionIdentifier="a8431fd0-e8a7-11e2-91e2-0800200c" SequenceNbr="1" TransactionStatusCode="Start"
 RetransmissionIndicator="false" CorrelationID="57ab4200-e8a7-11e2-91e2-0800200c9a66"

4.2 Originator - Specifies the sender of the message

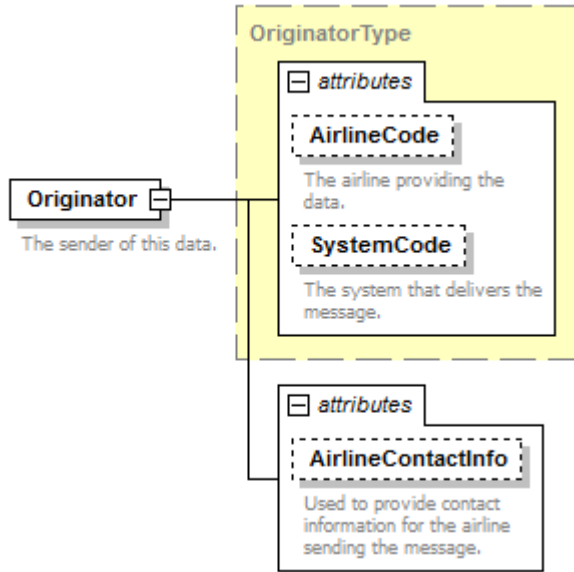

Originator (Mandatory)

Data Item	Type	Max Occurs	Comments
AirlineCode	an2..3	1	The airline providing the data.
SystemCode	an2..3	1	The system that delivers the message.
AirlineContactInfo	string	1	Contact information for the airline sending the message.

Example:

```
<Originator AirlineCode="SQ" SystemCode="1A" AirlineContactInfo="1-800-AIR-LINE"/>
```

4.3 FlightLeg - the flight for which passenger data is being sent

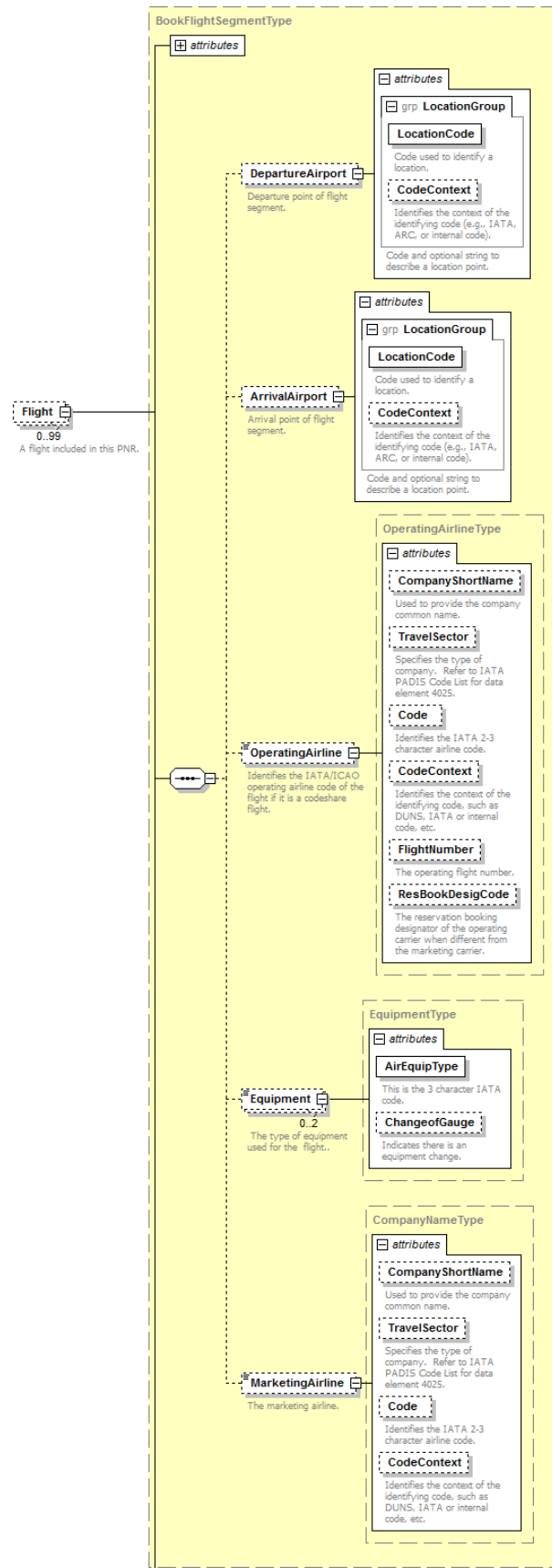

FlightLeg (Mandatory)

Data Item	Type	Max Occurs	Comments
CarrierCode	an2..3	1	The operating airline for this flight number
FlightNumber	n4	1	The flight number being reported on.
DepartureDateTime	YYYY-MM-DDTHH:MM:SS	1	The departure date and/or time of the flight leg.
ArrivalDateTime	YYYY-MM-DDTHH:MM:SS	1	The arrival date and/or time of the flight leg.
OperationalSuffix	a1	1	The operational suffix for this flight
DateChangeNbr	string	1	Contains the number of days by which the flights arrival date differs from its departure date.
CodeContext	string	1	Specifies if IATA or ICAO codes
DepartureAirport/ LocationCode	string	1	The IATA departure airport code for the flight
DepartureAirport/ CodeContext		NA	
ArrivalAirport/ LocationCode	string	1	The IATA arrival airport code for this flight.
ArrivalAirport/ CodeContext		NA	

Example:

```

<FlightLeg CarrierCode="SQ" FlightNumber="609" DepartureDateTime="2013-05-27T16:40:00"
  ArrivalDateTime="2013-05-28T22:00:00" DateChangeNbr="+1">
  <DepartureAirport LocationCode="ICN"/>
  <ArrivalAirport LocationCode="SIN"/>
</FlightLeg>

```

4.4 PNRs

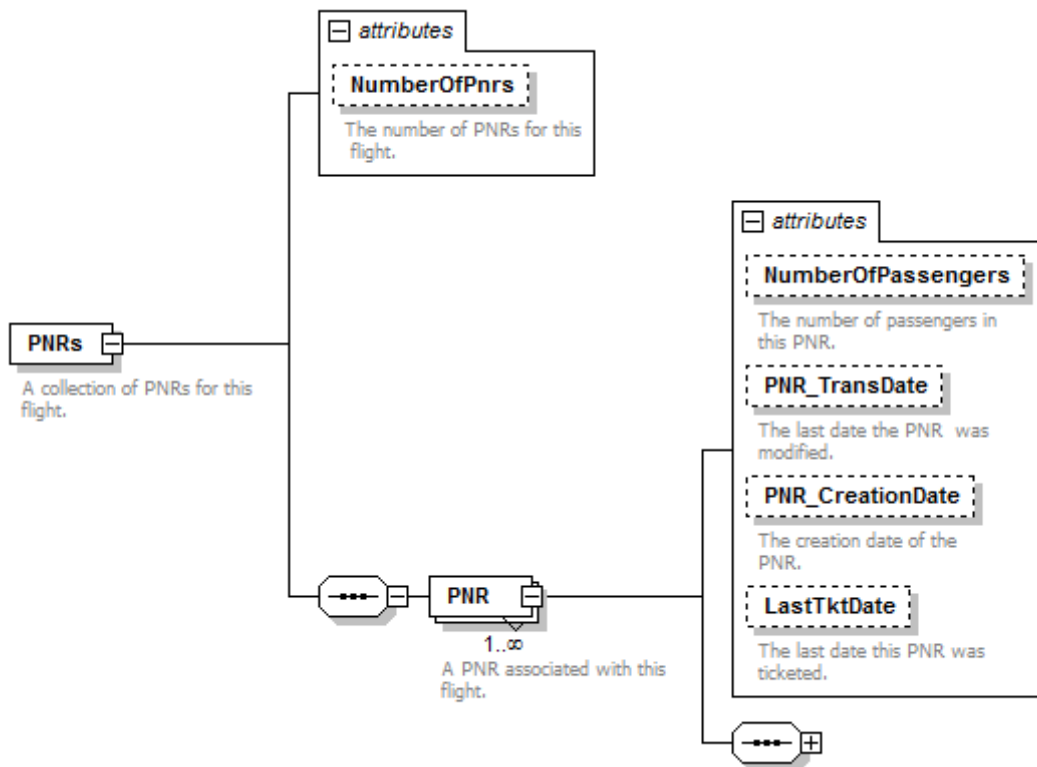

PNRs (Mandatory)

Data Item	Type	Max Occurs	Comments
NumberOfPNRs	integer	1	The total number of PNRs for this flight.

Example:

<PNRs NumberOfPnrs="6">

PNR (Mandatory)

Data Item	Type	Max Occurs	Comments
NumberOfPassengers	n..3	1	Number of passengers in this PNR.
PNR_TransDate	YYYY-MM-DD or YYYY-MM-DDTHH:MM:SS	1	The last date the PNR was modified
PNR_CreationDate	YYYY-MM-DD or YYYY-MM-DDTHH:MM:SS	1	The creation date of the PNR.
LastTktDate	YYYY-MM-DD or YYYY-MM-DDTHH:MM:SS	1	The last date this PNR was ticketed.

Example:

<PNR NumberOfPassengers="2" PNR_TransDate="2013-05-13T21:25:00" PNR_CreationDate="2013-05-01" LastTktDate="2013-05-13T21:24:00">

4.5 PNR – repeats for each passenger record

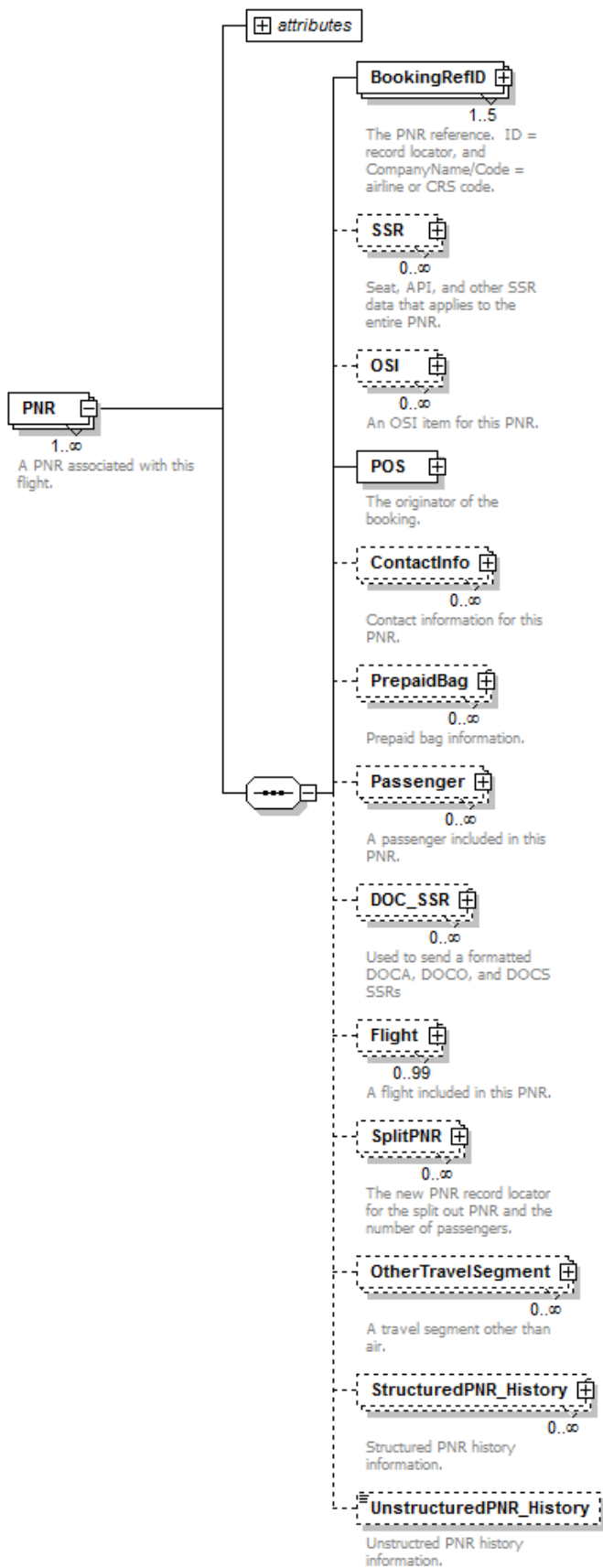

4.6 BookingRefID – the record locator for this passenger record

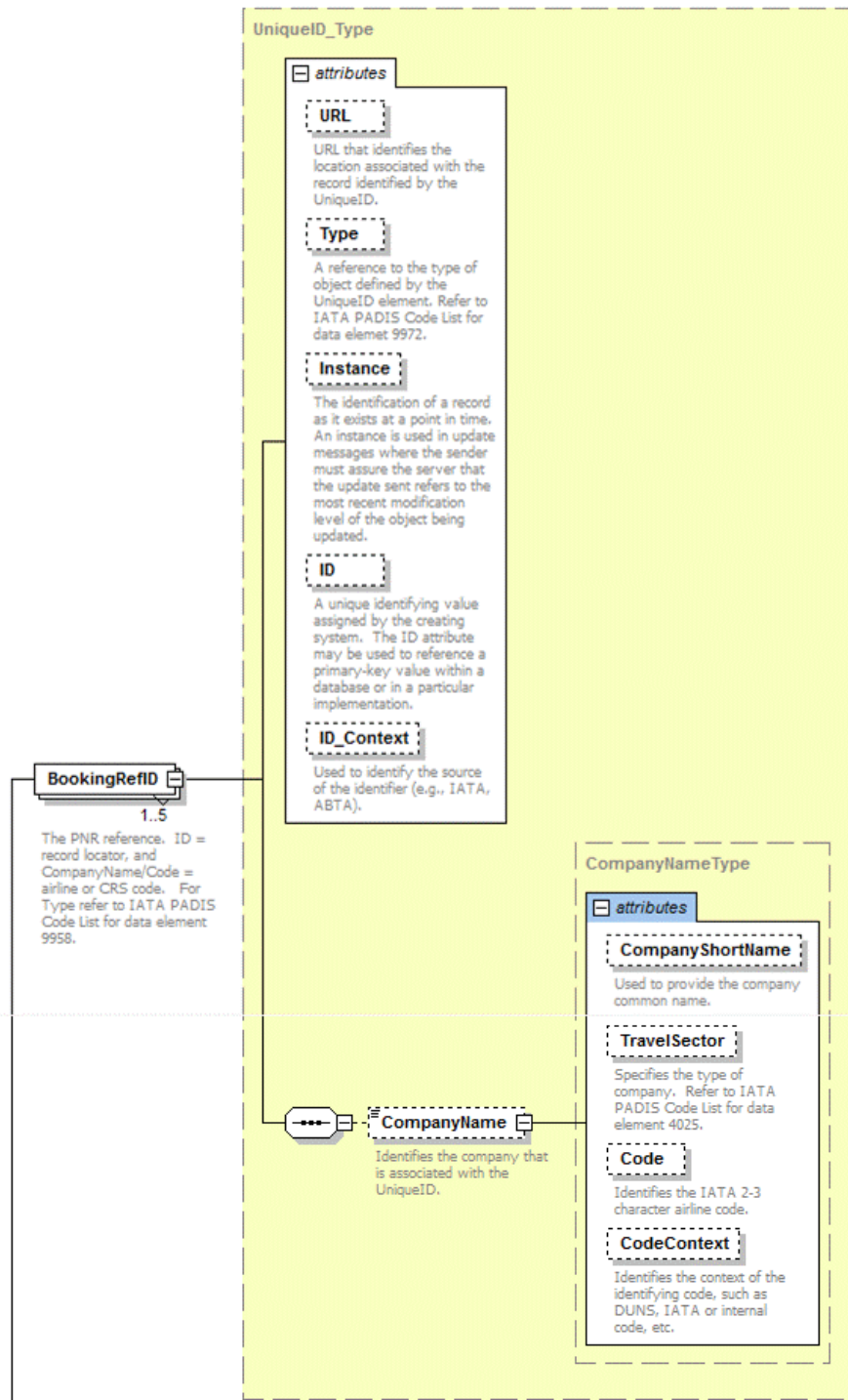

BookingRefID (Mandatory)

Data Item	Type	Max Occurs	Comments
URL		N/A	
Type	IATA_CodeType	1	Code identifying type of record reference: i.e. record locator number, confirmation number, etc..
Instance		N/A	
ID	string	1	Reference to a reservation record
ID_Context		N/A	
CompanyName/ CompanyShortName		N/A	
CompanyName/ TravelSector		N/A	
CompanyName/ Code	string	1	2-3 character airline/CRS code of the record reference
CompanyName/ CodeContext		N/A	

Example:

```

<BookingRefID ID="W9TEND">
  <CompanyName Code="TZ"/>
</BookingRefID>
  
```

4.7 SSR – special service data that applies to all passenger/flights

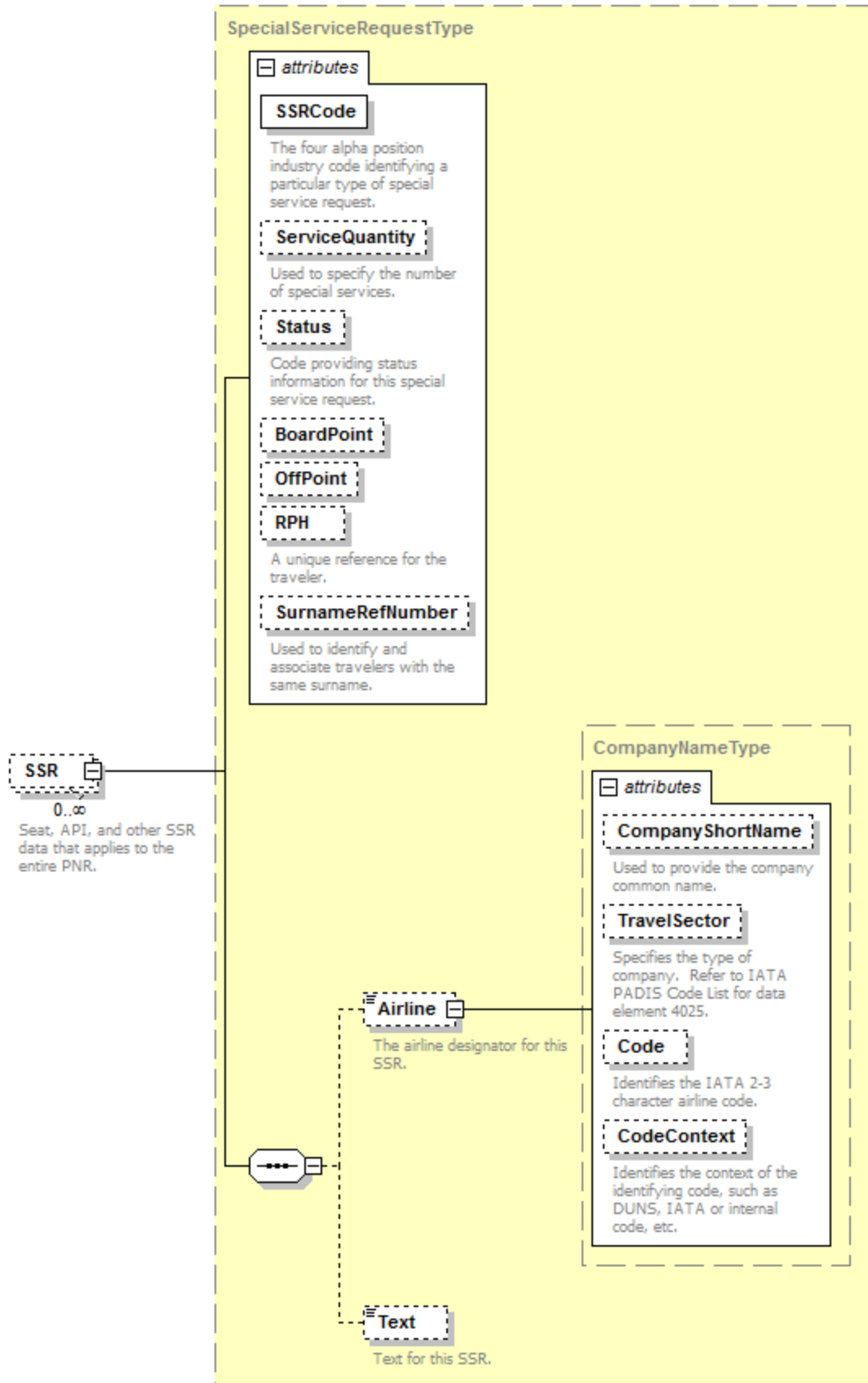

SSR

Data Item	Type	Max Occurs	Comments
SSRCode	a4	1	The industry code identifying a particular type of service request.
ServiceQuantity	n..2	1	Specifies the number of special services.
Status	a..2	1	Status for this special service request.
BoardPoint	an..5	1	The board city of the segment to which special service request applies.
OffPoint	an..5	1	The off city of the segment to which special service request applies.
RPH	string	1	A unique reference for this SSR
SurnameRefNumber	string	1	Used to identify and associate travellers with the same surname.
Airline/CompanyShortName		N/A	
Airline/TravelSector		N/A	
Airline/Code	string	1	Airline code identifying the system to which special service applies.
Airline/CodeContext		N/A	
Text	string	1	Text for this SSR.

Example:

```

<SSR SSRCode="OTHS" ServiceQuantity="1" Status="HK" BoardPoint="SIN" OffPoint="OOL"
  RPH="1234234">
  <Airline Code="TZ" />
  <Text>ADV TKT NUMBER BY 03MAY13 1800CO OR WILL CANCEL</Text>
</SSR>
  
```

4.8 OSI – other service information for all passengers/flights

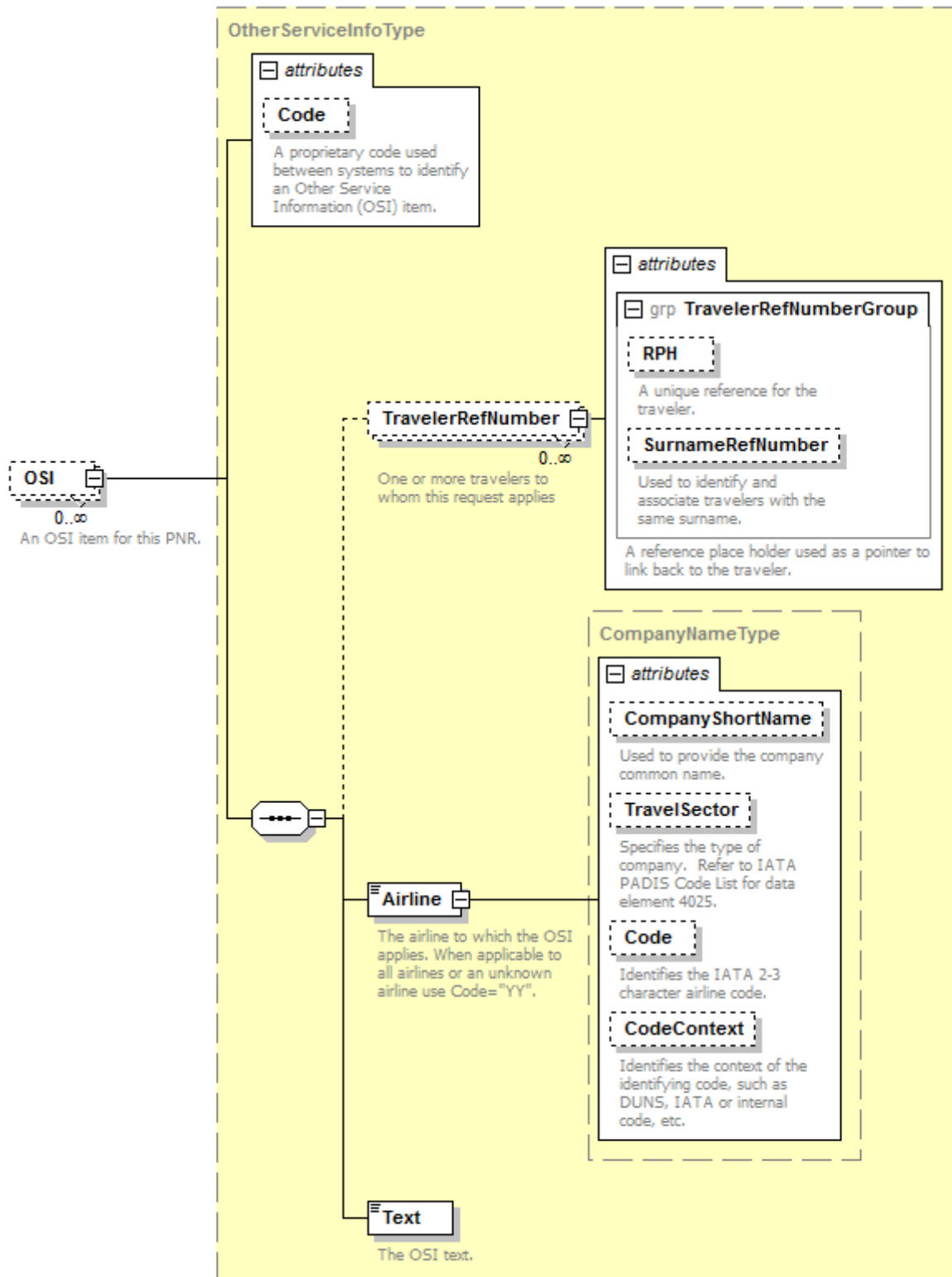

OSI

Data Item	Type	Max Occurs	Comments
Code	an..4	1	A proprietary code used between systems to identify other service information (OSI) item.
TravellerRefNumber/RPH	string	1	A unique reference for the traveller
TravellerRefNumber/SurnameRefNumber	string	1	Used to identify and associate travellers with the same surname.
Airline/CompanyShortName		N/A	
Airline/TravelSector		N/A	
Airline/Code	string	1	Airline code identifying system to which OSI applies.
Airline/CodeContext		N/A	
Text	string	1	Text for this OSI.

Example:

```

<OSI Code="CTC">
  <TravelerRefNumber RPH="1234234" />
  <Airline Code="TZ"/>
  <Text>7732486972</Text>
</OSI>

```

4.9 POS – origination of the booking

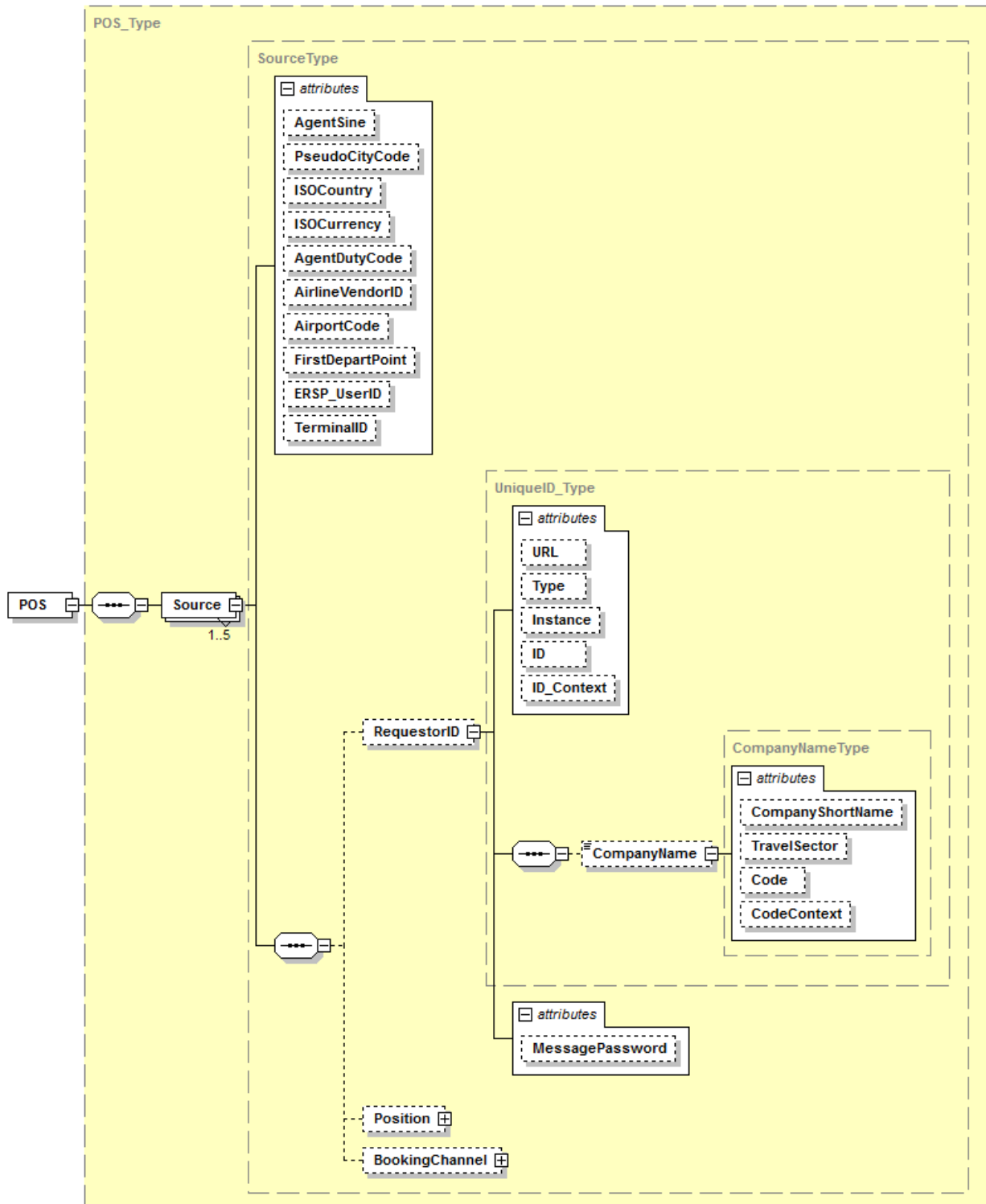

POS (Mandatory)

Data Item	Type	Max Occurs	Comments
Source/AgentSine	string	1	Identifies the party within the requesting entity.
Source/PseudoCityCode	string	1	An identification code assigned to an office/agency by a reservation system.
Source/ISOCountry	a2	1	The country code of the requesting party.
Source/ISOCurrency	a3	1	The currency code in which the reservation will be ticketed.
Source/AgentDutyCode	string	1	An authority code assigned to a requestor.
Source/AirlineVendorID	an2..3	1	The IATA assigned airline code.
Source/AirportCode	an..3	1	The IATA assigned airport code.
Source/FirstDepartPoint	an..3	1	The point of first departure in a trip.
Source/ERSP_UserID		N/A	
Source/TerminalID		N/A	
Source/RequestorID/URL		N/A	
Source/RequestorID/Type	an..3	1	Specifies the originator booking type. i.e. airline, travel agency, etc.
Source/RequestorID/Instance		N/A	
Source/RequestorID/ID	n..9	1	IATA travel agency ID number or pseudo IATA travel agency number.
Source/RequestorID/IDContext		N/A	
Source/RequestorID/MessagePassword		N/A	
Source/RequestorID/CompanyName/CompanyShortName		N/A	
Source/RequestorID/CompanyName/TravelSector		N/A	
Source/RequestorID/CompanyName/Code	an..3	1	Identifies the IATA 2-3 airline/CRS code of the system that originates the message when different from the delivering system.
Source/RequestorID/CompanyName/CodeContext		N/A	
Source/Position		N/A	
Source/BookingChannel		N/A	

Example:

```

<POS>
  <Source AgentSine="HDQKE2400" PseudoCityCode="MUC" ISOCountry="KR" ISOCurrency="KRW"
    AgentDutyCode="3482192" AirlineVendorID="KE" AirportCode="NBE">
    <RequestorID ID="123456789">
      <CompanyName Code="TZ"/>
    </RequestorID>
  </Source>
</POS>
  
```

4.10 ContactInfo – contact information (phone, address, email)

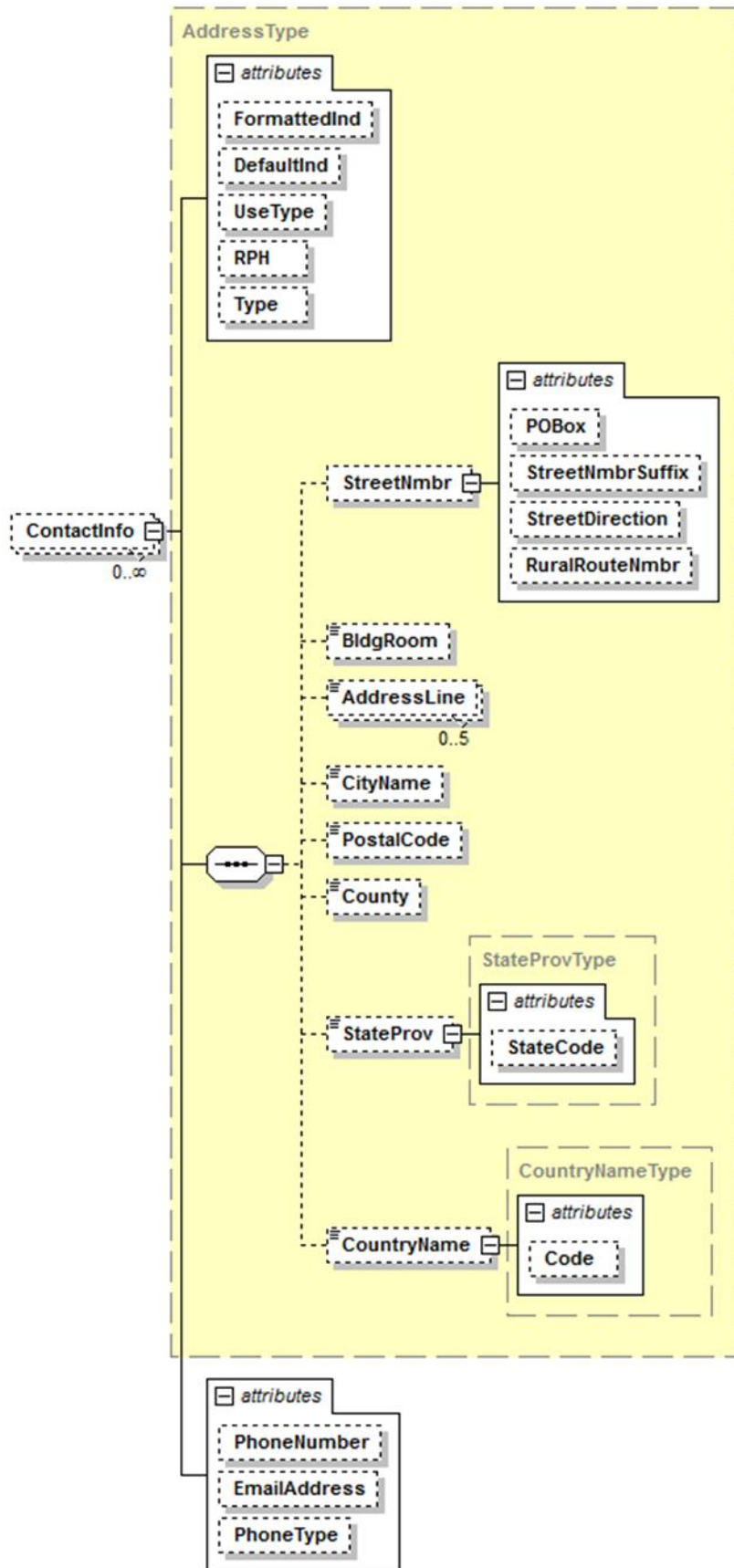

ContactInfo

Data Item	Type	Max Occurs	Comments
FormattedInd	boolean	1	Specifies if the associated data is formatted or not. When true it is formatted; when false, not formatted.
DefaultInd		N/A	
UseType		N/A	
RPH		N/A	
Type	IATA_CodeType	1	Defines the type of address.
StreetNmbr/POBox	string	1	The PO box number for this address
StreetNmbr/StreetNmbrSuffix	string	1	Used to send the address street number.
StreetNmbr/StreetDirection	string	1	The street direction of an address, such as north, south.
StreetNmbr/RuralRouteNmbr	string	1	The rural route number for an address.
BldgRoom	string	1	The building room name or number.
AddressLine	string	5	Unformatted address line
CityName	string	1	City, town, postal station
PostalCode	string	1	Post office code number
County	string	1	County/region name
StateProv/StateCode	string	1	State/prov/region code
CountryName/Code	a2	1	ISO3166 code for a country
PhoneNumber	string	1	A contact phone number
EmailAddress	string	1	An email address for the PNR.
PhoneType	IATA_CodeType	1	To specify the type of phone number, home, mobile.

Example:

```

<ContactInfo PhoneNumber="5555555" PhoneType="4" EmailAddress="bob@domain.com">
  <StreetNmbr StreetNmbrSuffix="123" StreetDirection="NW"/>
  <AddressLine>ANY STREET</AddressLine>
  <CityName>LAKE TOWN</CityName>
  <PostalCode>55123</PostalCode>
  <StateProv StateCode="MN"/>
  <CountryName Code="US"/>
</ContactInfo>
  
```

4.11 PrePaidBag – prepaid baggage amounts

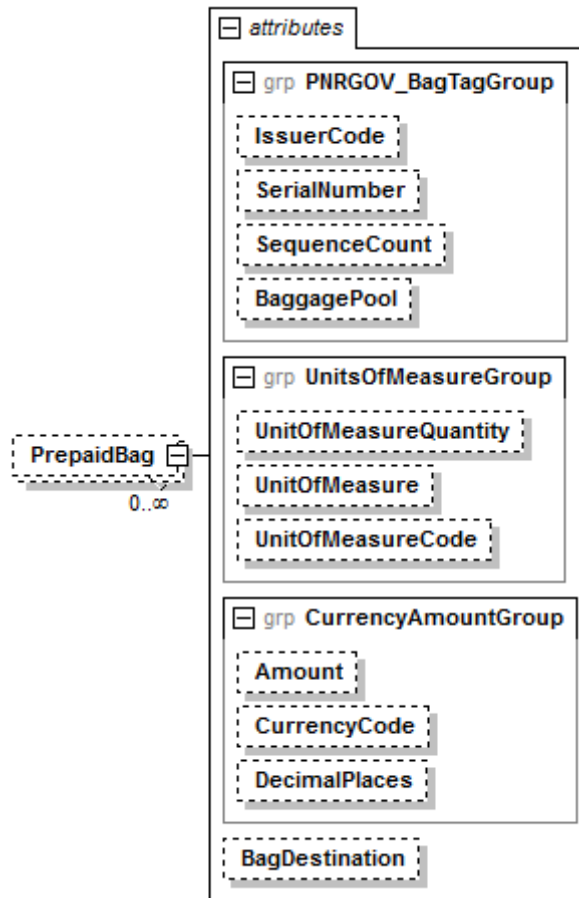

PrepaidBag

Data Item	Type	Max Occurs	Comments
IssuerCode	an..3	1	Issuer of the bagtag numbers
SerialNumber	string	1	Bag tag number
SequenceCount	n..2	1	Number of sequential bag tag numbers
BaggagePool	IATA_CodeType	1	Specifies head of pool or member of pool.
UnitOfMeasureQuantity	decimal	1	Weight or number of pieces.
UnitOfMeasure		N/A	
UnitOfMeasureCode	IATA_CodeType	1	If quantity is number of pieces or weight.
Amount	Decimal	1	Baggage fee
CurrencyCode	an..3	1	Currency code for baggage fee. Use ISO4217.
DecimalPlace		N/A	
BagDestination	an..5	1	Final destination for baggage.

Example:

```
<PrepaidBag UnitOfMeasureQuantity="2" UnitOfMeasureCode="700" Amount="26.00" CurrencyCode="CAD" BagDestination="SIN"/>
```

4.12 Passenger – passenger surname, given name, PTC code (repeats for each passenger)

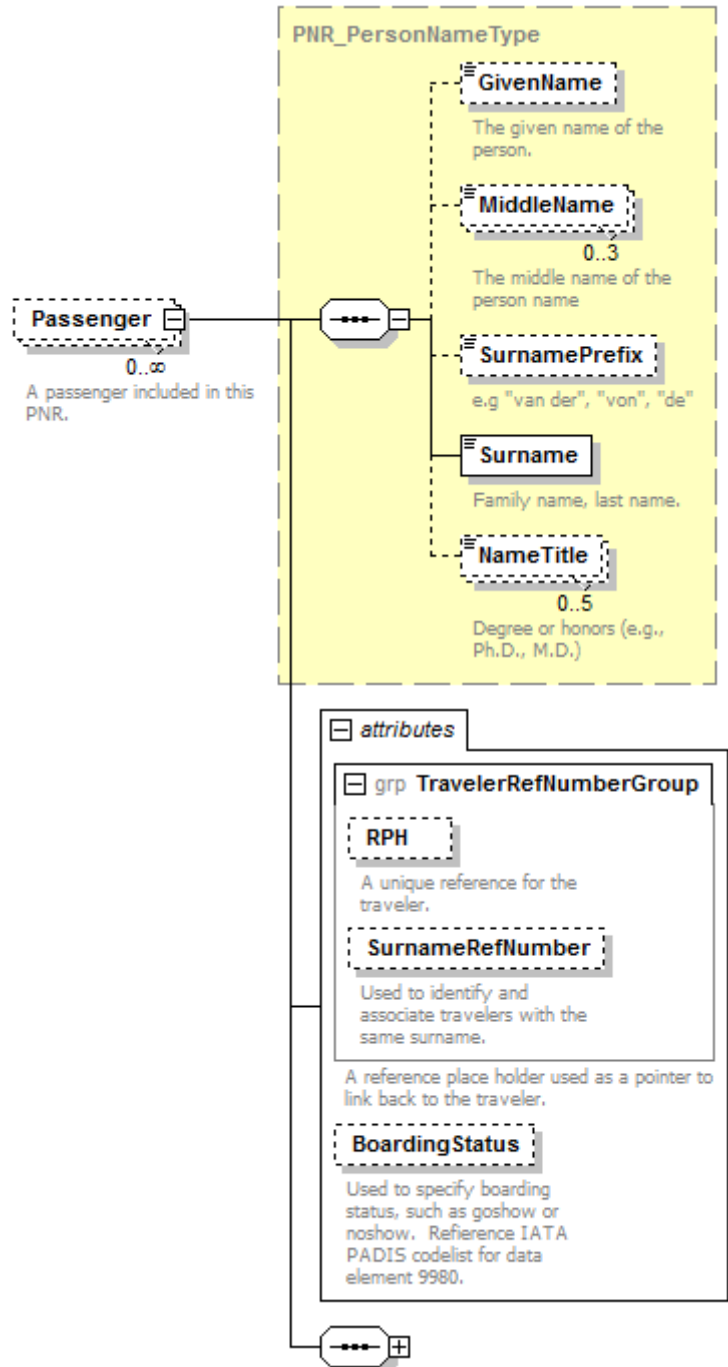

Passenger

Data Item	Type	Max Occurs	Comments
GivenName	an..64	1	Given name of the passenger
MiddleName	an..64	3	Middle name of the passenger
SurnamePrefix	an..16	1	Passenger surname prefix
Surname	an..64	1	The family or last name of the passenger
NameTitle	an..16	5	The title for the passenger
RPH	string	1	A reference for the passenger
SurnameRefNumber	string	1	The reference number for passengers with the same surname.
BoardingStatus	IATA_CodeType	1	Specifies boarding status, such as goshow, noshow
AccompaniedByInfantInd	Boolean	1	When true, the passenger is traveling with an infant

Example:

```

<Passenger RPH="1234234" SurnameRefNumber="43576" BoardingStatus="63">
  <GivenName>KEVINMICHAELMR</GivenName>
  <Surname>DENBERG</Surname>

```

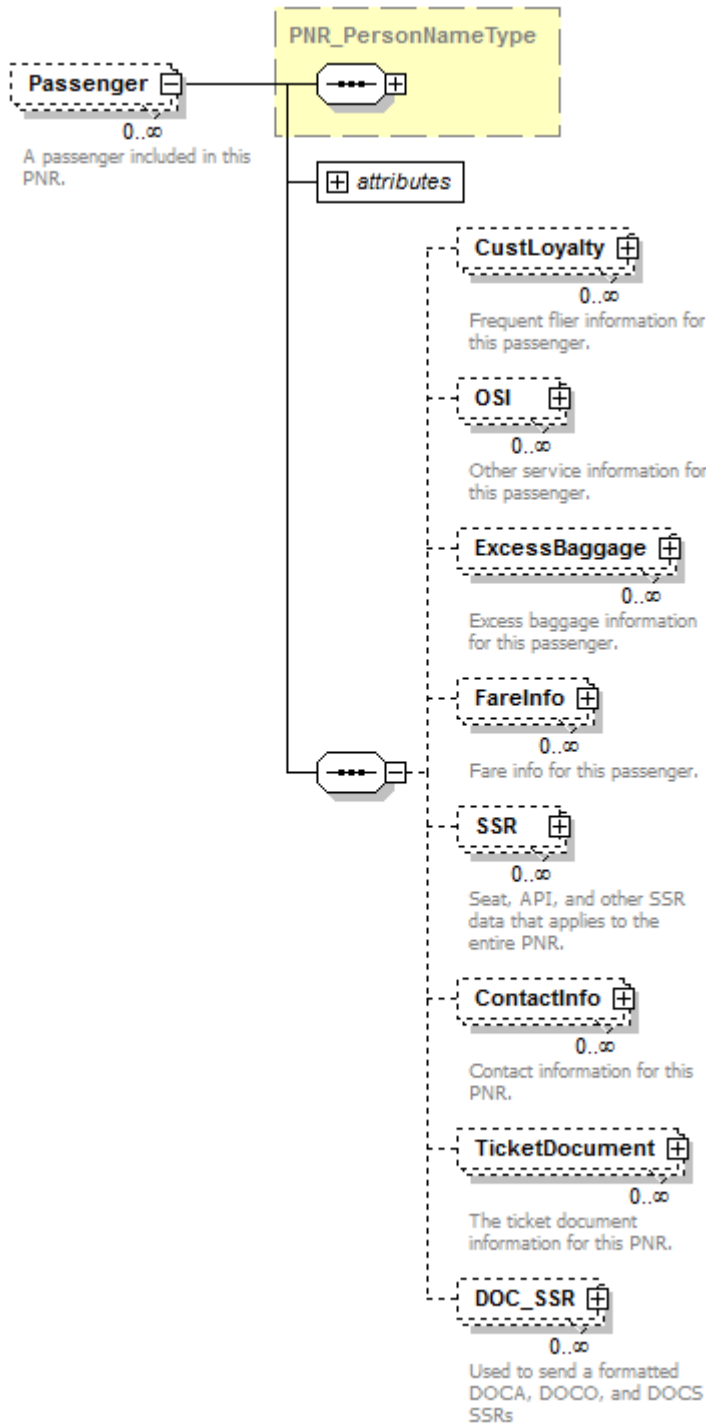

4.13 CustLoyalty – frequent traveler numbers for the passenger

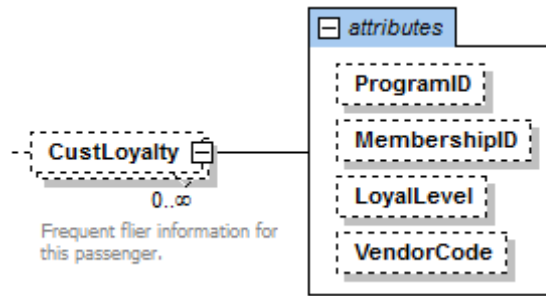

CustLoyalty

Data Item	Type	Max Occurs	Comments
ProgramID	string	1	Owner of the Frequent Flyer program
MembershipID	string	1	Frequent Flyer Number
LoyalLevel	string	1	Airline Status of FF level
VendorCode	string	1	Partner/vendor of FF number.

Example:

```
<CustLoyalty ProgramID="TZ" MembershipID="1234567"/>
```

4.14 OSI – other service information for a passenger

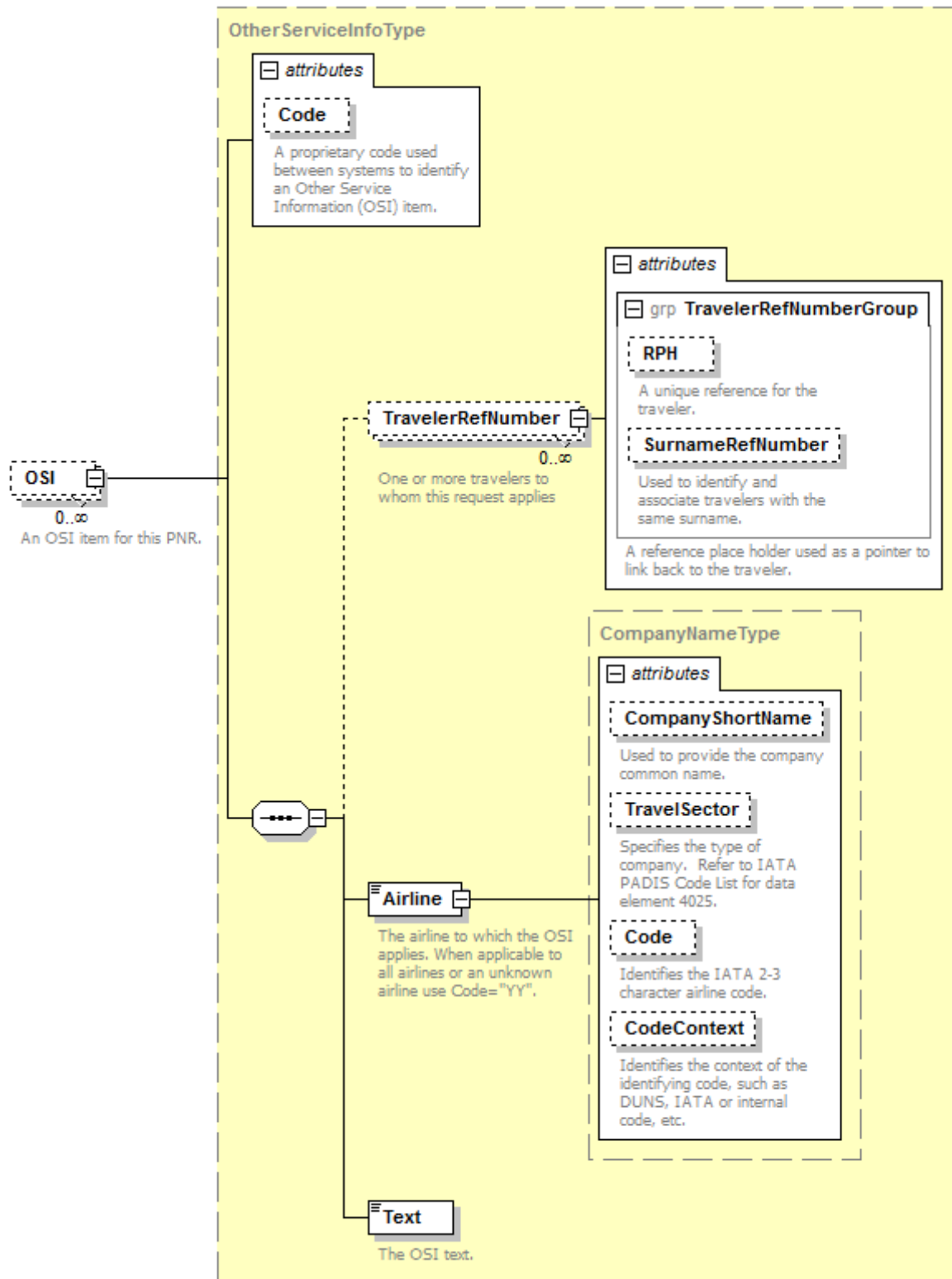

OSI

Data Item	Type	Max Occurs	Comments
Code	an..4	1	A proprietary code used between systems to identify other service information (OSI) item.
TravellerRefNumber/RPH	string	1	A unique reference for the traveller
TravellerRefNumber/SurnameRefNumber	string	1	Used to identify and associate travellers with the same surname.
Airline/CompanyShortName		N/A	
Airline/TravelSector		N/A	
Airline/Code	string	1	Airline code identifying system to which OSI applies.
Airline/CodeContext		N/A	
Text	string	1	Text for this OSI.

Example:

```

<OSI Code="CTC">
  <TravelerRefNumber RPH="1234234" />
  <Airline Code="TZ"/>
  <Text>7732486972</Text>
</OSI>

```

4.15 ExcessBaggage – excess baggage information for all passengers/flights

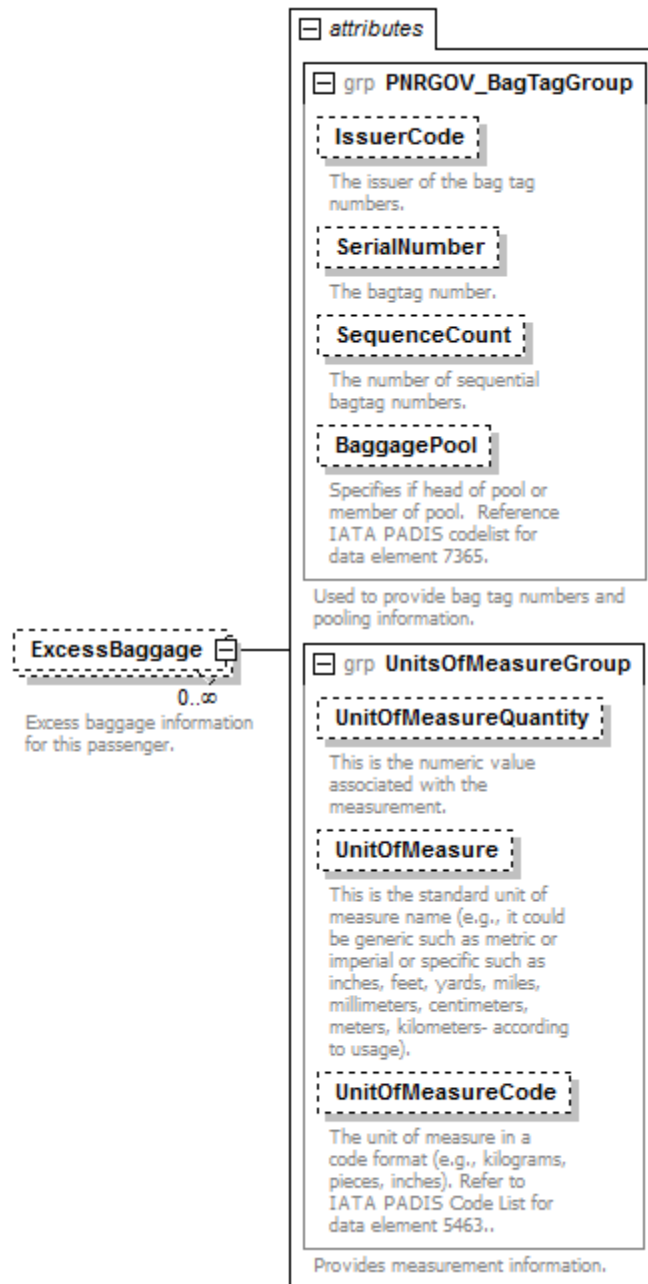

ExcessBaggage

Data Item	Type	Max Occurs	Comments
IssuerCode	an..3	1	Issuer of the bagtag number(s)
SerialNumber	string	1	Bag tag number
SequenceCount	n..2	1	Number of sequential bag tag number(s)
BaggagePool	IATA_CodeType	1	Specifies head of pool or member of pool.
UnitOfMeasureQuantity	decimal	1	Weight or number of pieces.
UnitOfMeasure		N/A	
UnitOfMeasureCode	IATA_CodeType	1	If quantity is number of pieces or weight.

Example:

```
<ExcessBaggage IssuerCode="SQ" SerialNumber="0012313122" SequenceCount="1" BaggagePool="MP"
  UnitOfMeasureQuantity="20" UnitOfMeasureCode="700"/>
```

4.16 FareInfo – fare and unstructured fare calculation information

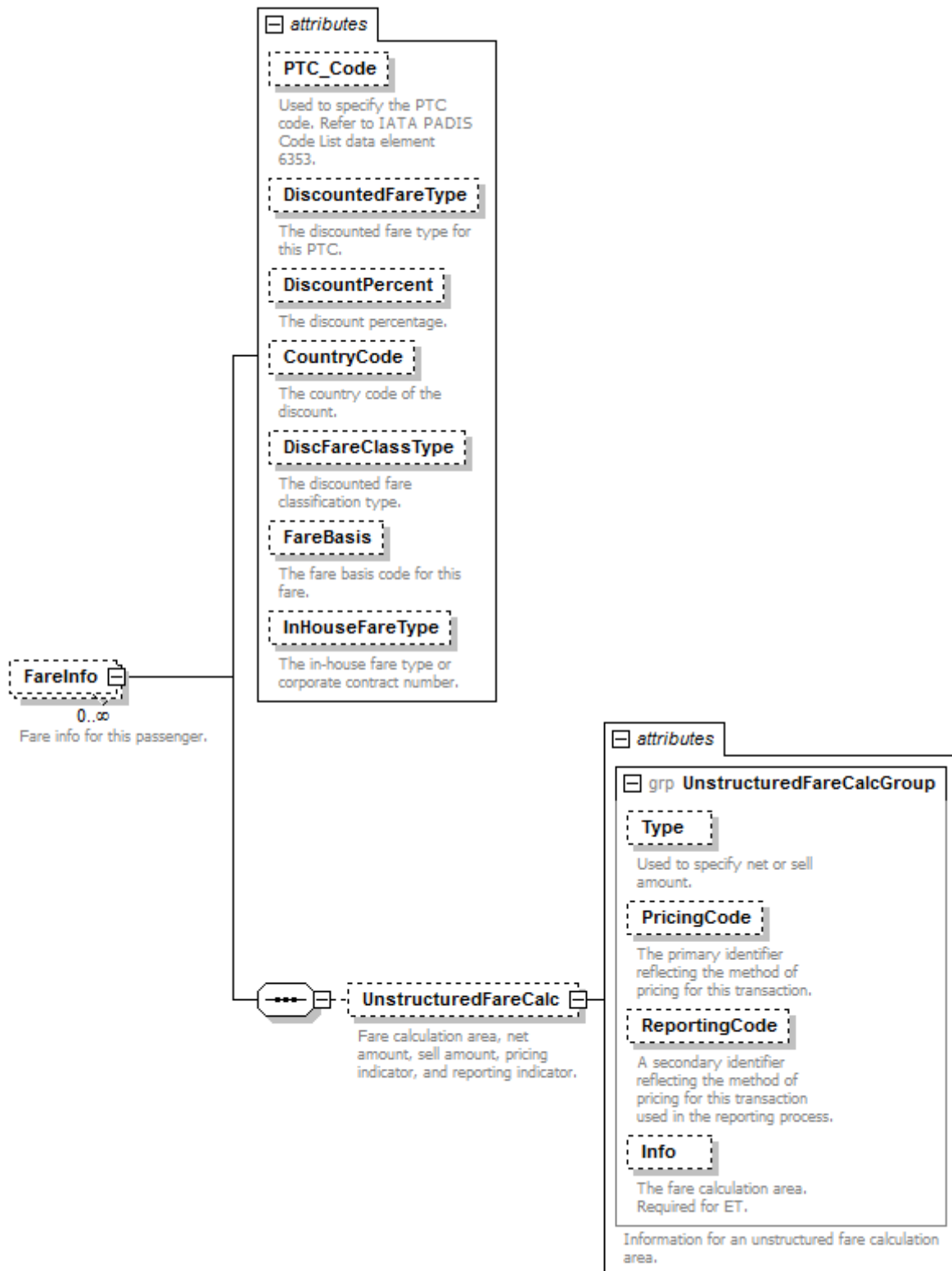

FareInfo

Data Item	Type	Max Occurs	Comments
PTC_Code	IATA_CodeType	1	Specify the Passenger Type Code
DiscountedFareType	IATA_CodeType	1	Discounted fare type for PTC
DiscountPercent	Percentage	1	The discount percentage
CountryCode	a2	1	The ISO3166 code of the discount
DiscFareClassType	IATA_CodeType	1	The discounted fare classification type
FareBasis	string	1	The fare basis code for the fare
InHouseFareType	an	1	The in-house fare type or corporate contract number
UnstructuredFareCalc/Type		N/A	
UnstructuredFareCalc/ PricingCode	an1	1	The method of pricing for this fare calculation
UnstructuredFareCalc ReportingCode	an1	1	Secondary identifier of the method of pricing
UnstructuredFareCalc/Info	string	N/A	The fare calculation area

Example:

```
<FareInfo PTC_Code="A" DiscountedFareType="764" DiscountPercent="5" CountryCode="US"
  DiscFareClassType="B2" FareBasis="SFLY"/>
```

4.17 SSR – special service data that applies to the passenger for all the flights

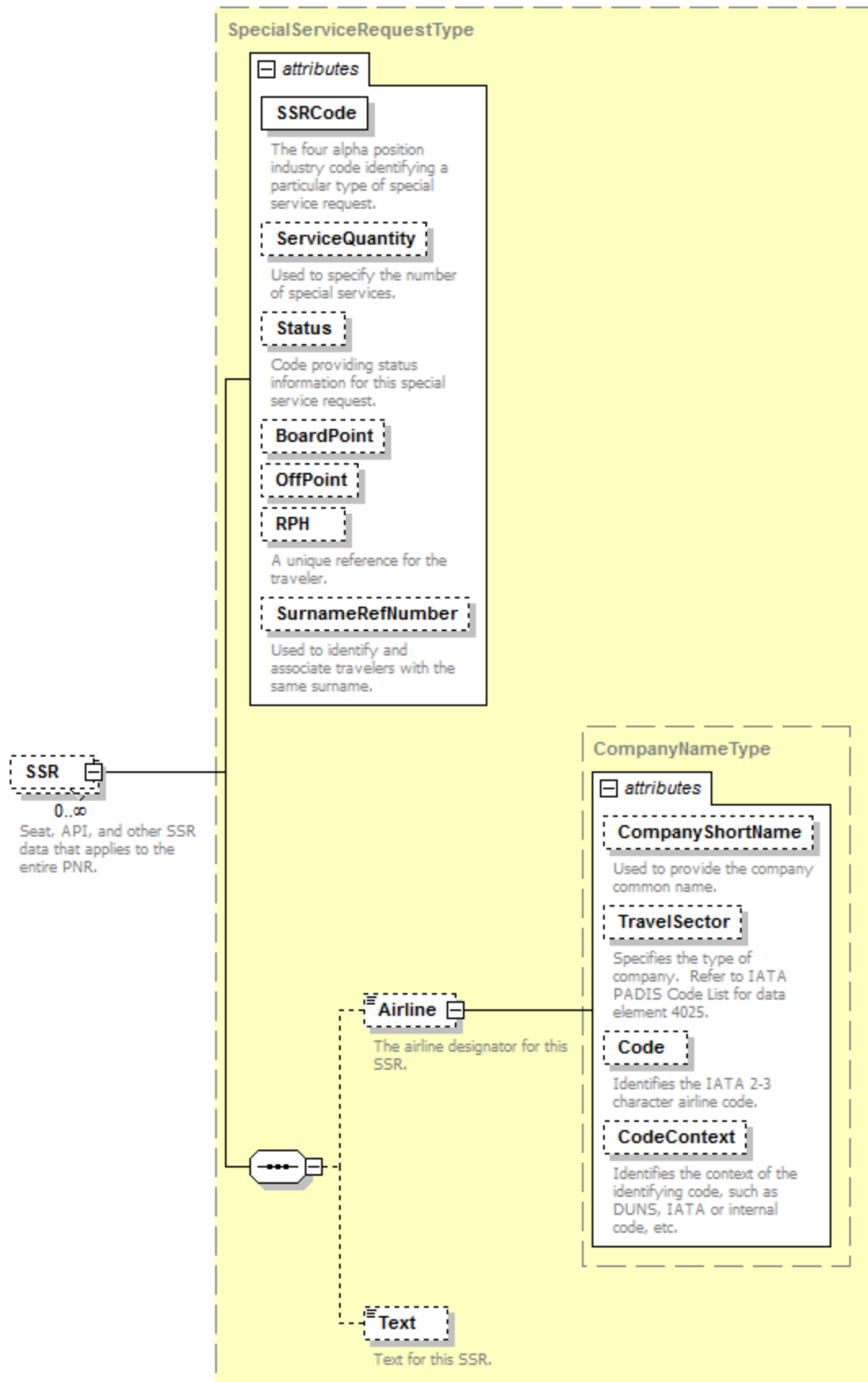

SSR

Data Item	Type	Max Occurs	Comments
SSRCode	a4	1	The industry code identifying a particular type of service request.
ServiceQuantity	n..2	1	Specifies the number of special services.
Status	a..2	1	Status for this special service request.
BoardPoint	an..5	1	The board city of the segment to which special service request applies.
OffPoint	an..5	1	The off city of the segment to which special service request applies.
RPH	string	1	A unique reference for this SSR
SurnameRefNumber	string	1	Used to identify and associate travellers with the same surname.
Airline/CompanyShortName		N/A	
Airline/TravelSector		N/A	
Airline/Code	string	1	Airline code identifying the system to which special service applies.
Airline/CodeContext		N/A	
Text	string	1	Text for this SSR.

Example:

```

<SSR SSRCode="NSSA" ServiceQuantity="1" Status="HN" BoardPoint="ICN" OffPoint="SIN" RPH="1234234"
  SurnameRefNumber="1">
  <Airline Code="SQ"/>
  <Text>MADDOX/MOLLY</Text>
</SSR>
  
```

4.18 ContactInfo – emergency contact information

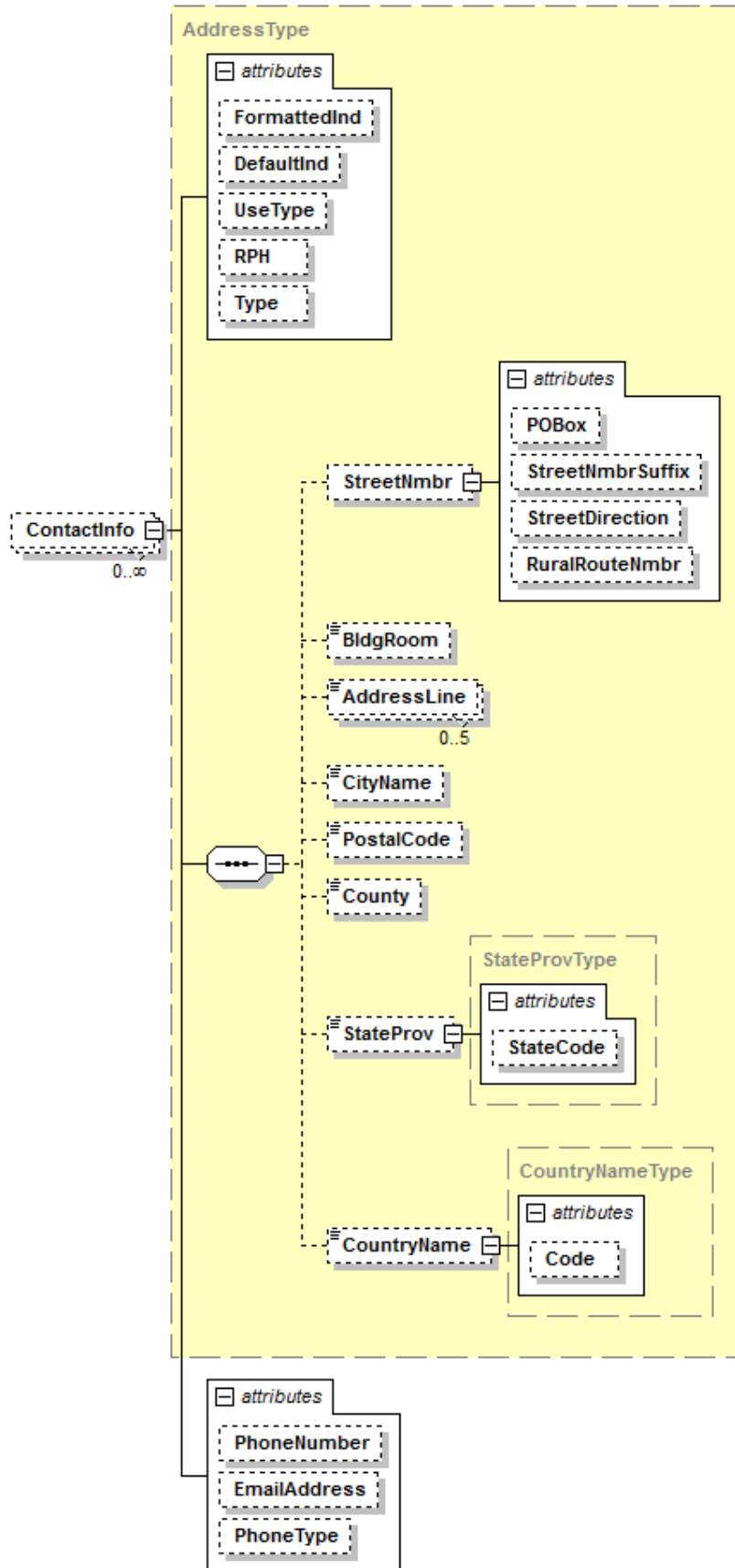

ContactInfo

Data Item	Type	Max Occurs	Comments
FormattedInd	boolean	1	Specifies if the associated data is formatted or not. When true it is formatted; when false, not formatted.
DefaultInd		N/A	
UseType		N/A	
RPH		N/A	
Type	IATA_CodeType	1	Defines the type of address.
StreetNmbr/POBox	string	1	The PO box number for this address
StreetNmbr/ StreetNmbrSuffix	string	1	Used to send the address street number.
StreetNmbr/StreetDirection	string	1	The street direction of an address, such as north, south.
StreetNmbr/ RuralRouteNmbr	string	1	The rural route number for an address.
BldgRoom	string	1	The building room name or number.
AddressLine	string	5	Unformatted address line
CityName	string	1	City, town, postal station
PostalCode	string	1	Post office code number
County	string	1	County/region name
StateProv/StateCode	string	1	State/Prov/region code
CountryName/Code	a2	1	ISO3166 code for a country
PhoneNumber	string	1	A contact phone number
EmailAddress	string	1	An email address for the PNR.
PhoneType	IATA_CodeType	1	To specify the type of phone number, home, mobile.

Example:

```
<ContactInfo PhoneNumber="7705555555" PhoneType="3"/>
```

4.19 TicketDocument – ticket document number, date and place of issue and reasons for issuance code and subcode (EMDs)

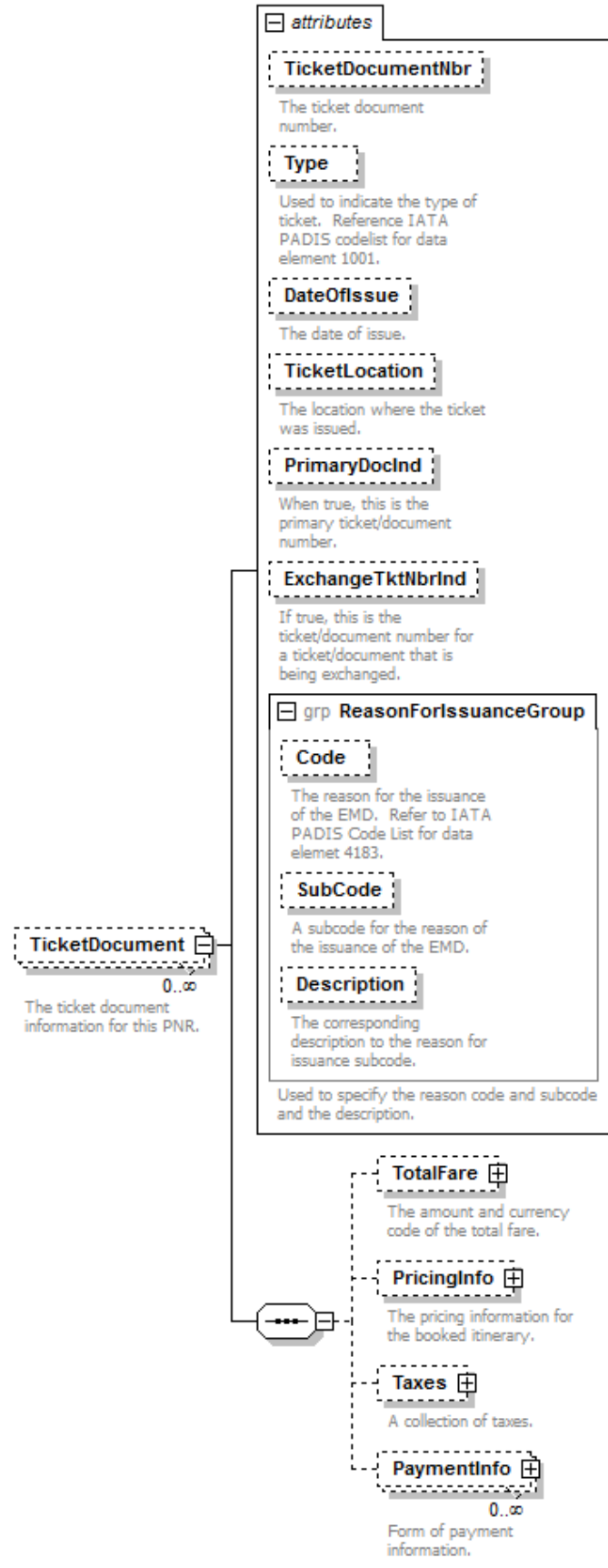

TicketDocument

Data Item	Type	Max Occurs	Comments
TicketDocumentNbr	string	1	Ticket/document number
Type	IATA_CodeType	1	Specifies type of ticket/document, such as electronic ticket, EMD-S, etc.
DateOfIssue	YYYY-MM-DD	1	Date the ticket/document was issued
TicketLocation	an	1	Location where the ticket was issued
PrimaryDocInd	Boolean	1	When true, this is the primary ticket/document number
ExchangeTktNbrInd	Boolean	1	When true, this is the ticket/document that was exchanged.
ReasonForIssuanceCode	IATA_CodeType	1	The EMD reason for issuance code
ReasonForIssuanceSubCode	an	1	The EMD reason for issuance subcode
Description	string	1	The description for a reason for issuance subcode

Example:

```
<TicketDocument TicketDocumentNbr="121341212311" Type="1" DateOfIssue="2013-05-13" TicketLocation="SIN"
  PrimaryDocInd="true">
```

4.20 TotalFare – total fare amount

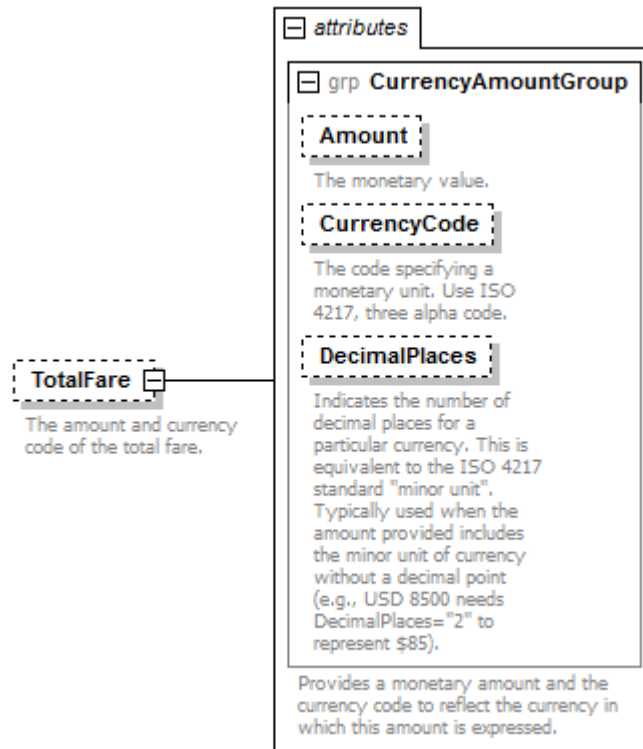

TotalFare

Data Item	Type	Max Occurs	Comments
Amount	decimal	1	The total ticket/document amount
CurrencyCode	a3	1	The currency code for this amount
DecimalPlaces		N/A	

Example:

<TotalFare Amount="1999.99" CurrencyCode="SGD"/>

4.21 PriceInfo – pricing date, time, ISO country code , and location

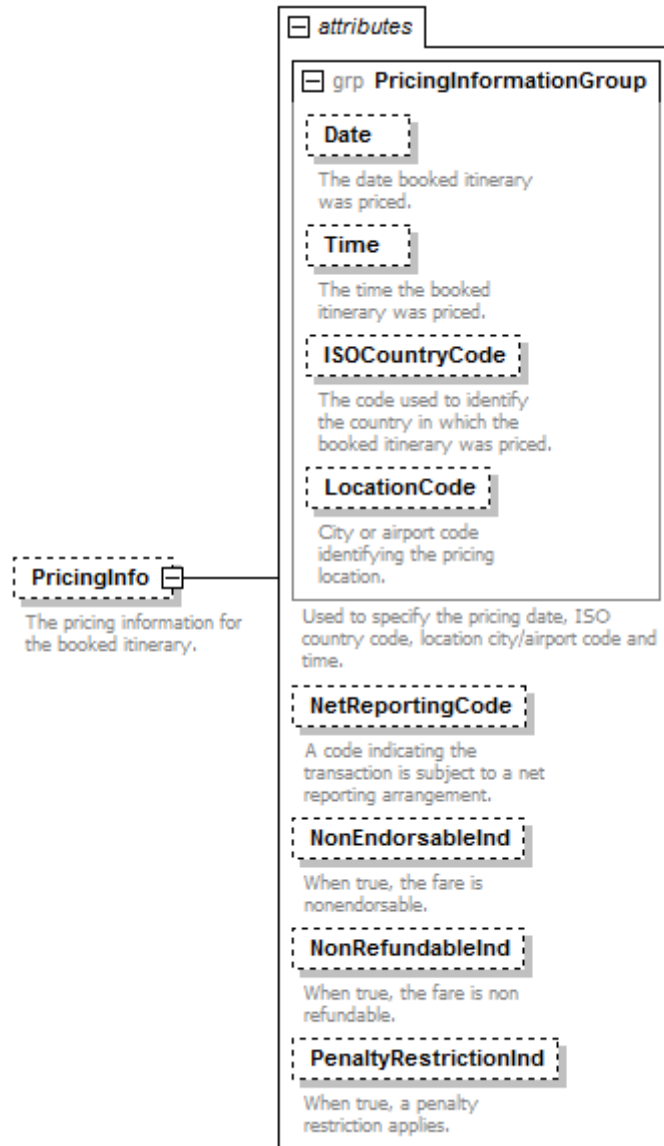

PriceInfo

Data Item	Type	Max Occurs	Comments
Date	YYYY-MM-DD	1	The date the booked itinerary was priced
Time	HH:MM:SS	1	The time the booked itinerary was priced
ISOCountryCode	a2	1	The country in which the booked itinerary was priced
LocationCode	a3	1	Airport/city code in which the booked itinerary was priced
NetReportingCode	an	1	The code indicating the transaction is subject to net reporting arrangement
NonEndorseableInd	Boolean	1	When true, the fare is non-endorsable
NonRefundableInd	Boolean	1	When true, the fare is non-refundable
PenaltyRestrictionInd	Boolean	1	When true, a penalty restriction applies

Example:

```
<PriceInfo Date="2013-05-01" Time="12:15:00" ISOCountryCode="CN" LocationCode="S1N"
  NonEndorsableInd="true" NonRefundableInd="true" PenaltyRestrictionInd="true"/>
```

4.22 Taxes/Tax – tax amount for the ticket

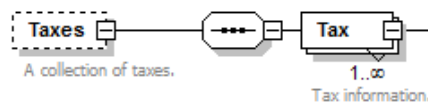

attributes

- grp FeeTaxGroup**

 - Qualifier**

Used to specify if current, paid, additional taxes. Refer to IATA PADIS Code list data element 5305.
 - ISOCountry**

Used to specify the ISO country code or special purpose code.
 - Amount**

The monetary value.
 - CurrencyCode**

The code specifying a monetary unit. Use ISO 4217, three alpha code.
 - DecimalPlaces**

Indicates the number of decimal places for a particular currency. This is equivalent to the ISO 4217 standard "minor unit". Typically used when the amount provided includes the minor unit of currency without a decimal point (e.g., USD 8500 needs DecimalPlaces="2" to represent \$85).
 - TaxType**

The tax designator code.
 - FiledAmount**

The tax filed amount.
 - FiledCurrencyCode**

The currency code in which the tax/fee/charge amount was filed.
 - FiledTaxType**

The filed two letter ticket tax code assigned by IATA.
 - ConversionRate**

The BSR and/or BBR used to convert the tax/fee/charge filed amount from filed currency into the tax/fee/charge amount in currency of country of payment.
 - Usage**

A code to indicate if the tax is non-refundable/non-interlineable or used/compensated or new paid. Refer to IATA PADIS Code List for data element 5007.

Defines the fees and/or taxes associated with a charge (e.g. taxes associated with a hotel rate).

Taxes/Tax

Data Item	Type	Max Occurs	Comments
Qualifier	IATA_CodeType	1	Specifies if current, paid, additional tax
ISOCountryCode	a2	1	ISO country code or special purpose code
Amount	decimal	1	The tax amount
CurrencyCode	a3	1	The currency code for the tax amount
DecimalPlaces		N/A	
TaxType	an	1	Tax designator code
FiledAmount		N/A	
FiledCurrencyCode		N/A	
FiledTaxType		N/A	
ConversionRate		N/A	
Usage		N/A	

Example:

```

<Taxes>
  <Tax Amount="99.99" ISOCountry="CN" CurrencyCode="SGD" TaxType="BK"/>
  <Tax Amount="99.99" ISOCountry="CN" CurrencyCode="SGD" TaxType="OO"/>
  <Tax Amount="99.99" ISOCountry="CN" CurrencyCode="SGD" TaxType="YY"/>
</Taxes>
  
```

4.23 PaymentInfo – form of payment, payment amount, credit card number and expiration date and sponsor information

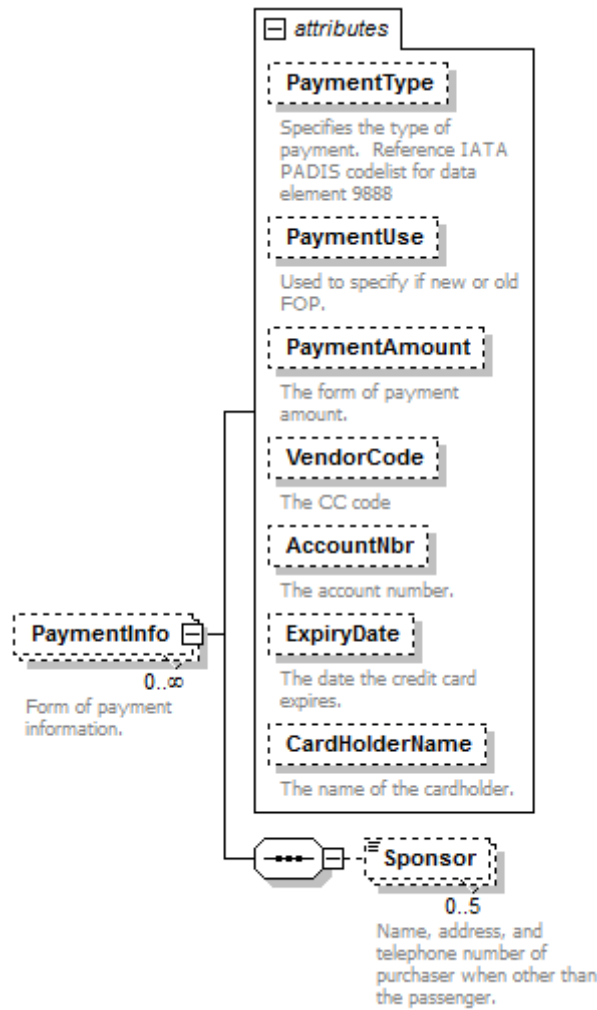

PaymentInfo

Data Item	Type	Max Occurs	Comments
PaymentType	IATA_CodeType	1	Specifies the type of payment.
PaymentUse	IATA_CodeType	1	Specifies if new or old form of payment
PaymentAmount	decimal	1	The form of payment amount
VendorCode	an	1	The credit card code.
AccountNbr	an	1	The credit card account number
ExpiryDate	MMYY	1	The expiration date of the credit card
CardHolderName	string	1	The name of the cardholder.
Sponsor	string	1	Name, address, and telephone number of purchaser when other than the passenger.

Example:

```

<PaymentInfo PaymentType="CC" PaymentUse="NEW" PaymentAmount="999.00" VendorCode="MC"
  AccountNbr="*****1344" ExpiryDate="1214" CardHolderName="KEVIN MICHAEL VON DENBERG"/>
  
```

4.24 DOC_SSR – formatted DOCA, DOCO, and DOCS SSR information

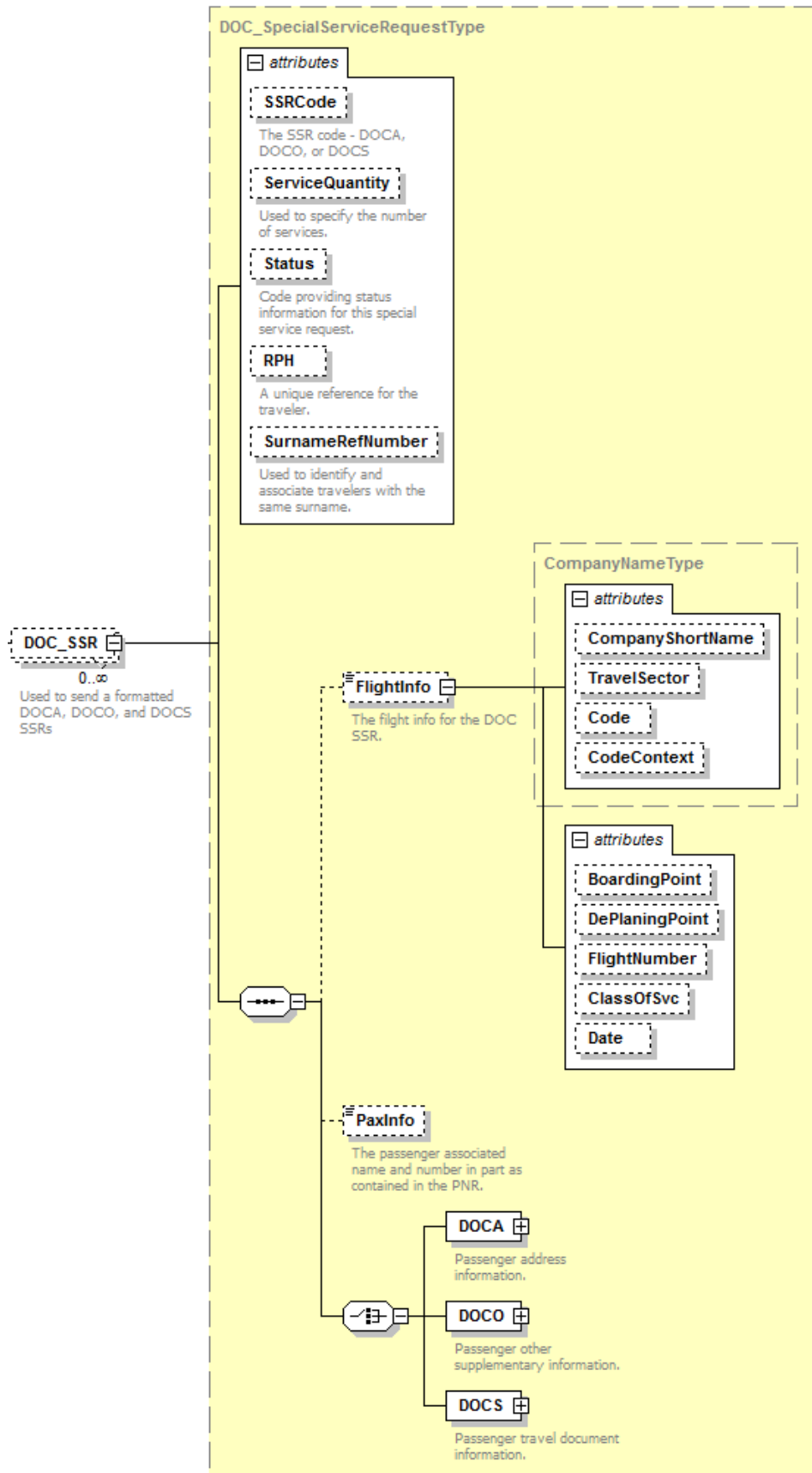

DOC_SSR

Data Item	Type	Max Occurs	Comments
SSRCode	a4	1	Specifies DOCA/DOCO/DOCS
ServiceQuantity	n..2	1	Number of services for SSR
Status	a..2	1	Status information for the SSR
RPH	string	1	A unique reference to the traveller
SurnameRefNbr	string	1	Used to reference a traveller with the same surname
FlightInfo/ CompanyShortName		N/A	
FlightInfo/ TravelSector		N/A	
FlightInfo/ Code	an..3	1	Airline code for this SSR
FlightInfo/ CodeContext		N/A	
FlightInfo/ BoardingPoint	an..5	1	City code where passenger boards this flight.
FlightInfo/ DePlanningPoint	an..5	1	City code where passenger deplanes.
FlightInfo/ FlightNumber	n..4	1	Flight number for this SSR
FlightInfo/ ClassOfSvc	a1	1	Class of service
FlightInfo/ Date	an7	1	Flight date in DDMMYY format
PaxInfo	string	1	Passenger associated name and number in part as contained in the PNR.

Example:

```

<DOC_SSR SSRCode="DOCA" ServiceQuantity="1" Status="HK">
  <FlightInfo Code="TZ"/>

```

4.25 DOCA – formatted passenger address SSR information

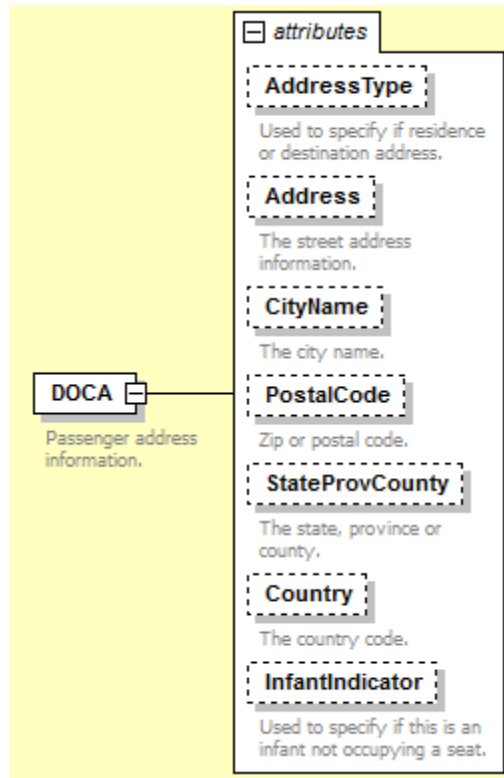

DOCA

Data Item	Type	Max Occurs	Comments
AddressType	a1	1	Used to specify resident or destination.
Address	string	1	Street address information
CityName	an..35	1	City name
PostalCode	an..17	1	Zip or Post code
StateProvCounty	an..35	1	State/Prov/County
Country	an..3	1	Country Code
InfantIndicator	a1	1	Specifies infant not occupying seat.

Example:

```
<DOC_SSR SSRCode="DOCA" ServiceQuantity="1" Status="HK">
  <FlightInfo Code="TZ"/>
  <DOCA AddressType="D" Address="123 Jefferson Ave" CityName="Atlanta" PostalCode="13445"
    StateProvCounty="GA" Country="USA"/>
</DOC_SSR>
```

4.26 DOCO – formatted passenger other supplementary SSR information

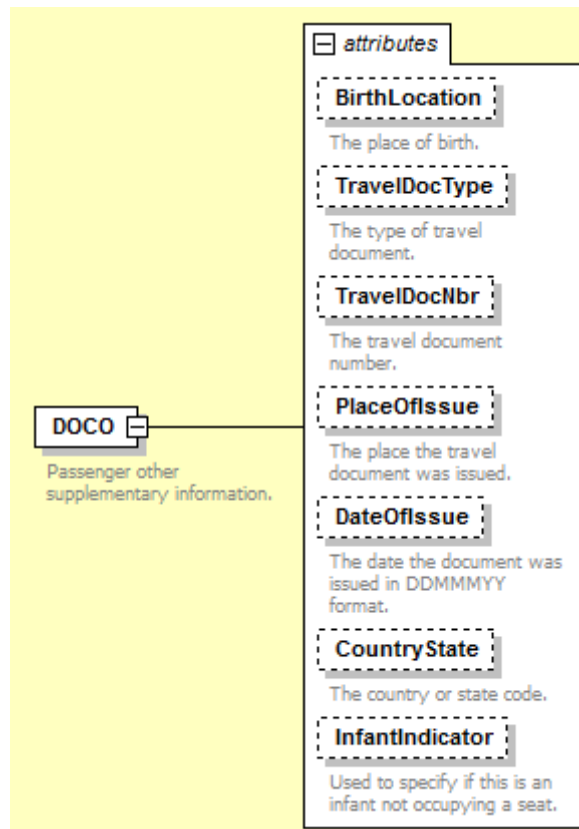

DOCO

Data Item	Type	Max Occurs	Comments
BirthLocation	an..35	1	Place of birth
TravelDocType	a1	1	Type of travel document
TravelDocNbr	an..25	1	Travel document number
PlaceOfIssue	an..35	1	Place travel document issued
DateOfIssue	an7	1	Date document issued in DDMMYY format
CountryState	an..3	1	Country/State code
InfantIndicator	a1	1	Specified this is an infant not occupying a seat

Example:

```
<DOC_SSR SSRCode="DOCO" ServiceQuantity="1" Status="HK">
  <DOCO BirthLocation="USA" TravelDocType="V" TravelDocNbr="1214213" PlaceOfIssue="CAN"
    DateOfIssue="02FEB12" CountryState="CAN"/>
</DOC_SSR>
```

4.27 DOCS - formatted travel document SSR information

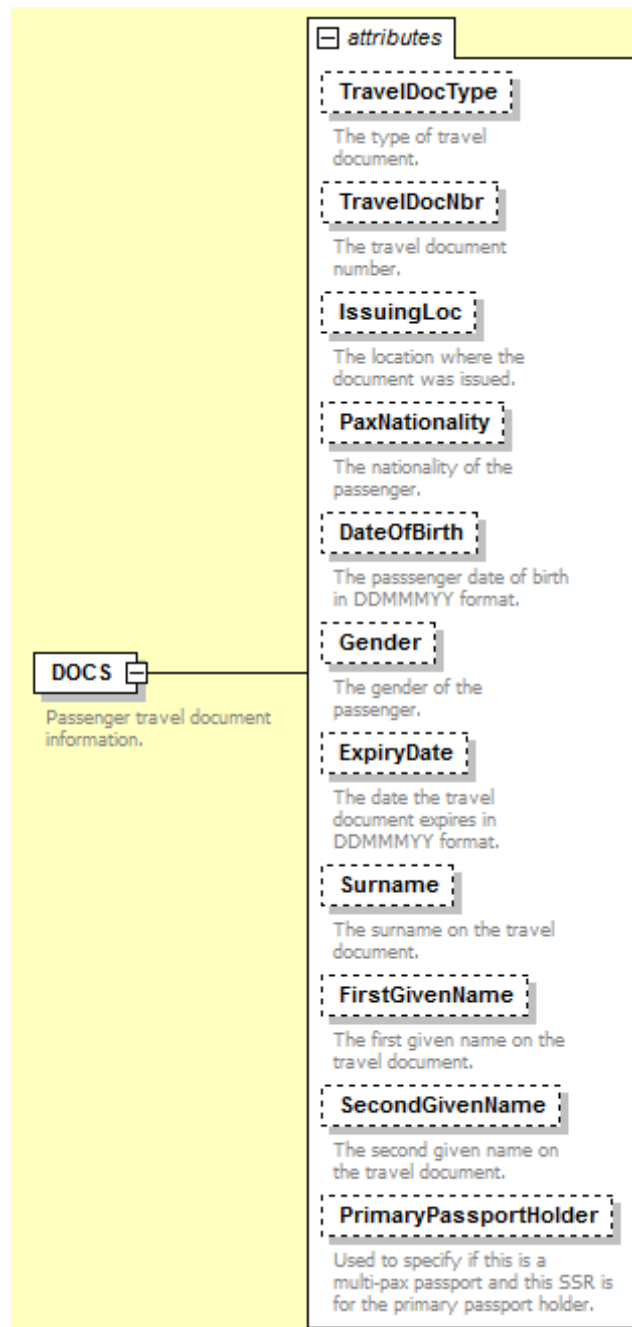

DOCS

Data Item	Type	Max Occurs	Comments
TravelDocType	an..2	1	Type of travel document
TravelDocNbr	an..15	1	Travel document number
IssuingLoc	an..3	1	Location where document issued
PaxNationality	an..3	1	Nationality of passenger
DateOfBirth	an7	1	Date of birth DDMMYY
Gender	a..2	1	Gender of passenger
ExpiryDate	an7	1	Date travel document expires DDMMYY
Surname	string	1	Surname on travel document
FirstGivenName	string	1	First given name on travel document
SecondGivenName	string	1	Second given name on travel document
PrimaryPassportHolder	a1	1	Specifies if this is a multi pax passport and this SSR is for the primary passport holder.

Example:

```

<DOC_SSR SSRCode="DOCS" ServiceQuantity="1" Status="HK">
  <DOCS DateOfBirth="04JUL80" ExpiryDate="12JAN19" FirstGivenName="KEVIN"
    SecondGivenName="MICHAEL" Surname="VON DENBERG" Gender="M" IssuingLoc="USA"
    PaxNationality="USA" TravelDocNbr="548721687" TravelDocType="P"/>
</DOC_SSR>
  
```

4.28 Flight – a flight in the itinerary for the passenger

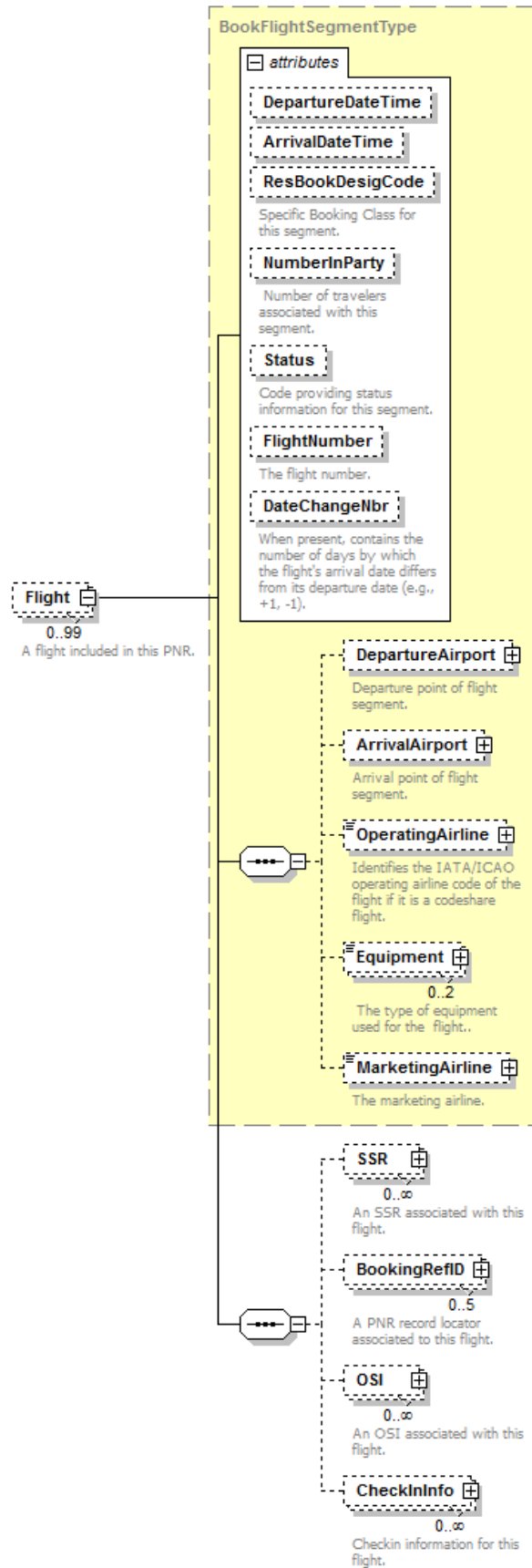

Flight

Data Item	Type	Max Occurs	Comments
DepartureDateTime	YYYY-MM-DDTHH:MM:SS or YYYY-MM-DD or HH:MM:SS	1	Departure date and time for the flight
ArrivalDateTime	YYYY-MM-DDTHH:MM:SS or YYYY-MM-DD or HH:MM:SS	1	Arrival date and time for the flight
ResBookDesigCode	a..2	1	Specific booking class
NumberInParty	integer	1	Number of travellers associated with this segment
Status	an..2	1	Status information for this segment
FlightNumber	an..4	1	Flight number of segment
DateChangeNbr	string	1	Identifies the number of days the arrival date differs from the date of departure.
DepartureAirport/ LocationCode	string	1	IATA airport code for departure airport
DepartureAirport/ CodeContext		N/A	
ArrivalAirport/ LocationCode	string	1	IATA airport code for arrival airport
ArrivalAirport/ CodeContext		N/A	
OperatingAirline/ CompanyShortName		N/A	
OperatingAirline/ TravelSector		N/A	
OperatingAirline/ Code	a..2	1	Code for airline
OperatingAirline/ CodeContext		N/A	
OperatingAirline/ FlightNumber	n..4	1	Operating flight number
OperatingAirline/ ResBookDesigCode	a..2	1	Reservation booking airline code when it differs from the operating code.
Equipment/ AirEquipType	an3	1	3 character IATA code for aircraft.
Equipment/ ChangeofGauge		N/A	
MarketingAirline/ CompanyShortName		N/A	
MarketingAirline/ TravelSector		N/A	
MarketingAirline/ Code	an..3	1	IATA marketing airline code
MarketingAirline/ CodeContext		N/A	

Example:

```

<Flight DepartureDateTime="2013-05-31T22:25:00" ArrivalDateTime="2013-05-29T07:50:00"
ResBookDesigCode="S"
  NumberInParty="1" Status="HK" FlightNumber="6">
  <DepartureAirport LocationCode="SIN"/>
  <ArrivalAirport LocationCode="OOL"/>
  <OperatingAirline Code="SQ" FlightNumber="4523" ResBookDesigCode="S"/>
  <MarketingAirline Code="TX"/>

```

4.29 SSR – special service requests that apply to this flight

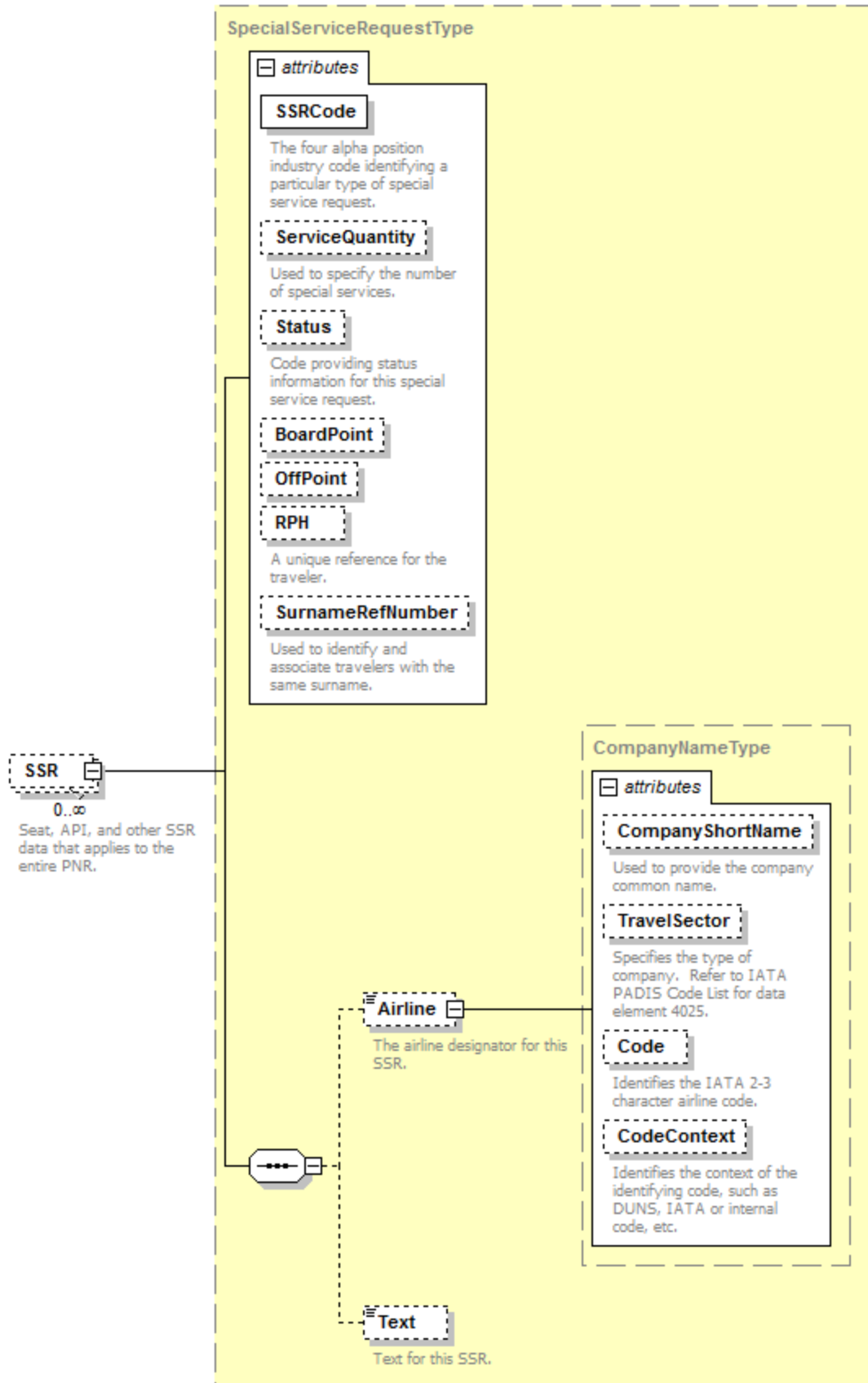

SSR

Data Item	Type	Max Occurs	Comments
SSRCode	a..4	1	The industry code identifying a particular type of service request.
ServiceQuantity	n..2	1	Specifies the number of special services.
Status	a..2	1	Status for this special service request.
BoardPoint	an..5	1	The board city of the segment to which special service request applies.
OffPoint	an..5	1	The off city of the segment to which special service request applies.
RPH	string	1	A unique reference for this SSR
SurnameRefNumber	string	1	Used to identify and associate travellers with the same surname.
Airline/CompanyShortName		N/A	
Airline/TravelSector		N/A	
Airline/Code	string	1	Airline code identifying the system to which special service applies.
Airline/CodeContext		N/A	
Text	string	1	Text for this SSR.

Example:

```

<SSR SSRCode="NSSA" ServiceQuantity="1" Status="HN" BoardPoint="ICN" OffPoint="SIN" RPH="1234234"
  SurnameRefNumber="1">
  <Airline Code="SQ"/>
  <Text>MADDOX/MOLLY</Text>
</SSR>
  
```

4.30 BookingRefID – passenger record locator specific to this flight

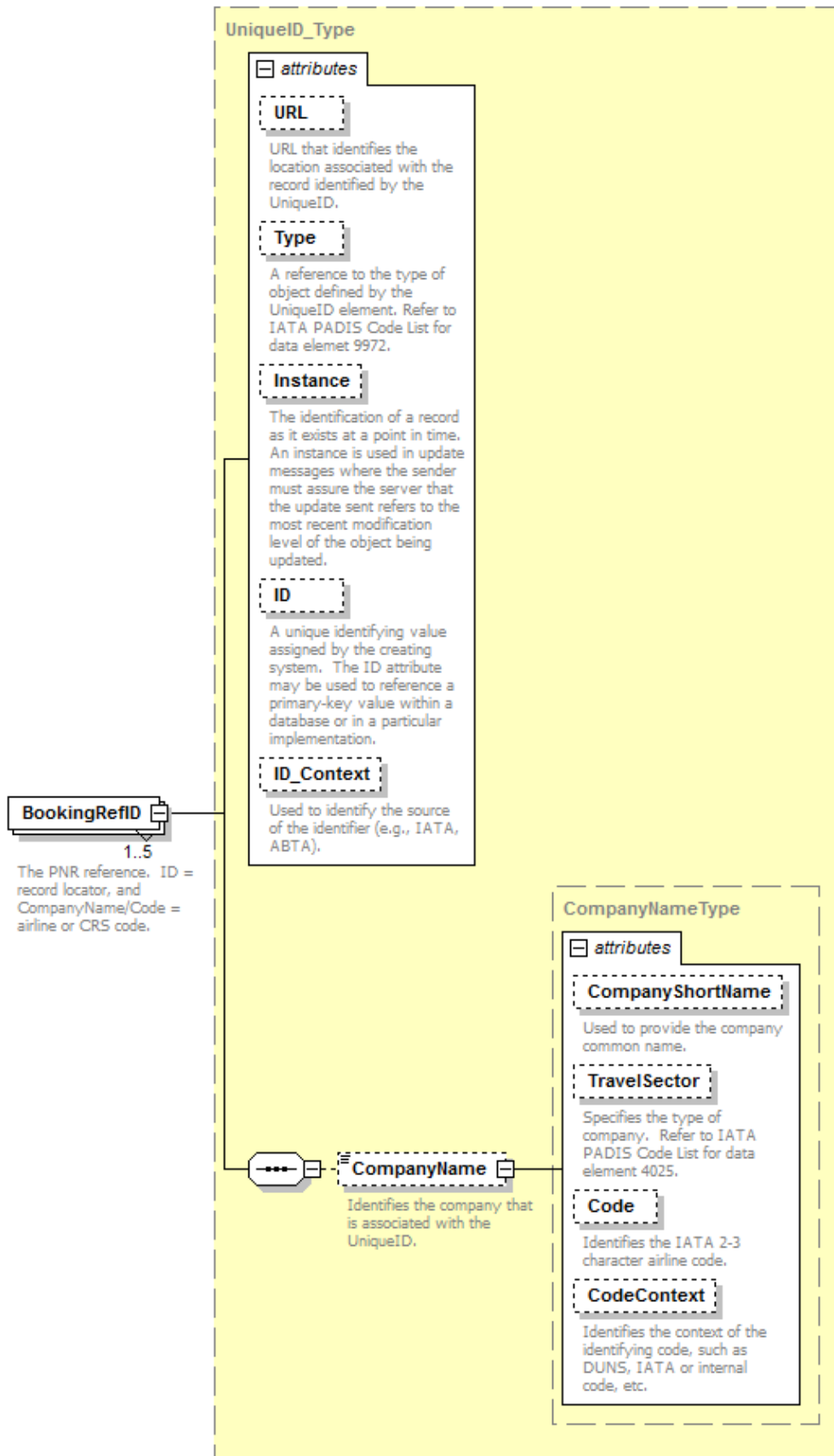

BookingRefID

Data Item	Type	Max Occurs	Comments
URL		N/A	
Type	IATA_CodeType	1	Code identifying type of record reference: i.e. record locator number, confirmation number, etc.
Instance		N/A	
ID	string	1	Reference to a reservation record
ID_Context		N/A	
CompanyName/ CompanyShortName		N/A	
CompanyName/ TravelSector		N/A	
CompanyName/Code	string	1	2-3 character airline/CRS code of the record reference
CompanyName/ CodeContext		N/A	

Example:

```

<BookingRefID ID="W9TEND">
  <CompanyName Code="TZ"/>
</BookingRefID>
  
```

4.31 OSI – other service information for this flight

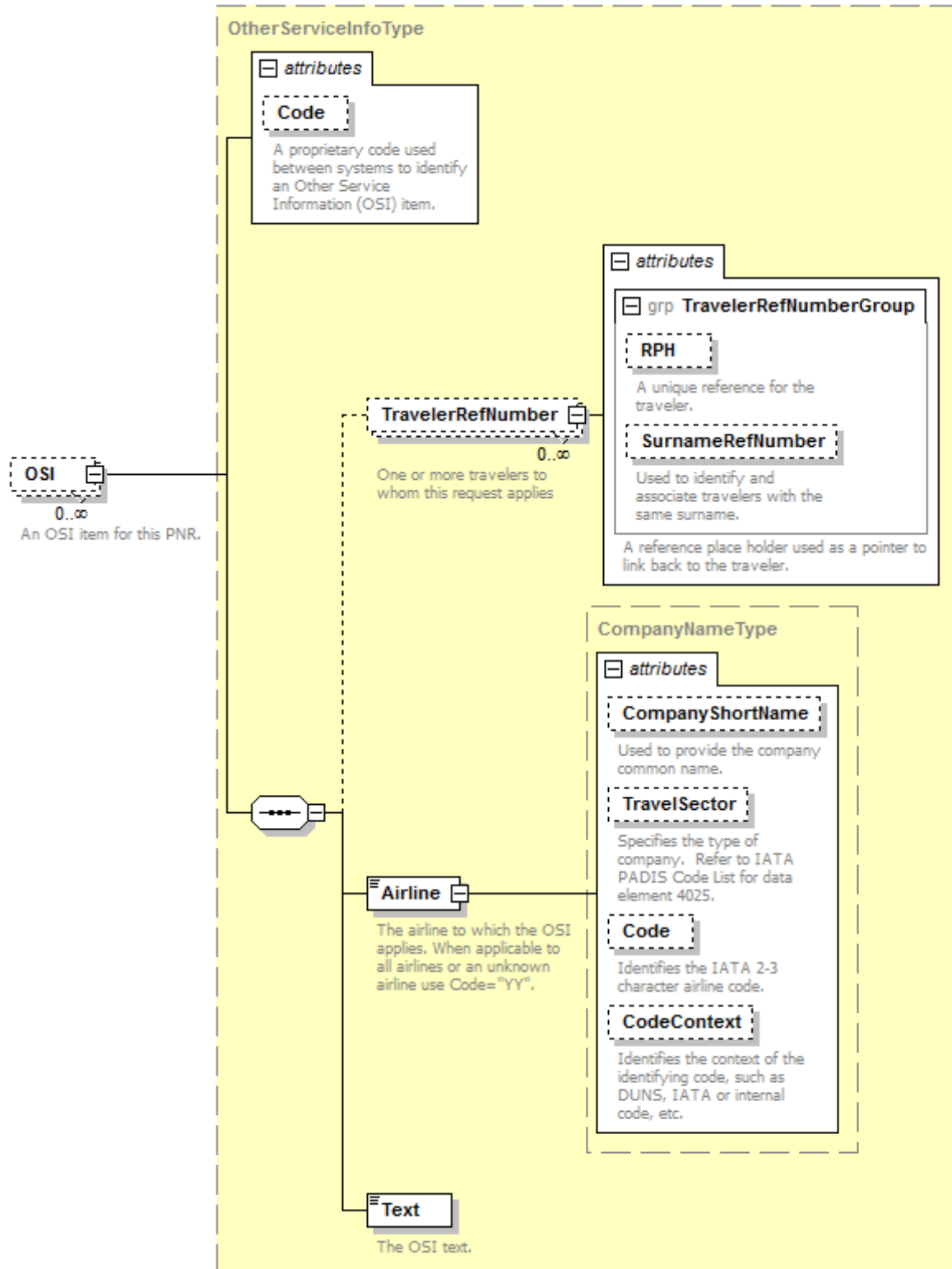

OSI

Data Item	Type	Max Occurs	Comments
Code	an..4	1	A proprietary code used between systems to identify other service information (OSI) item.
TravellerRefNumber/RPH	string	1	A unique reference for the traveller
TravellerRefNumber/SurnameRefNumber	string	1	Used to identify and associate travellers with the same surname.
Airline/CompanyShortName		N/A	
Airline/TravelSector		N/A	
Airline/Code	string	1	Airline code identifying system to which OSI applies.
Airline/CodeContext		N/A	
Text	string	1	Text for this OSI.

Example:

```
<OSI Code="CTC">  
  <TravelerRefNumber RPH="1234234" />  
  <Airline Code="TZ"/>  
  <Text>7732486972</Text>  
</OSI>
```

4.32 CheckInInfo – the check-in time and agent information that checked-in the passenger

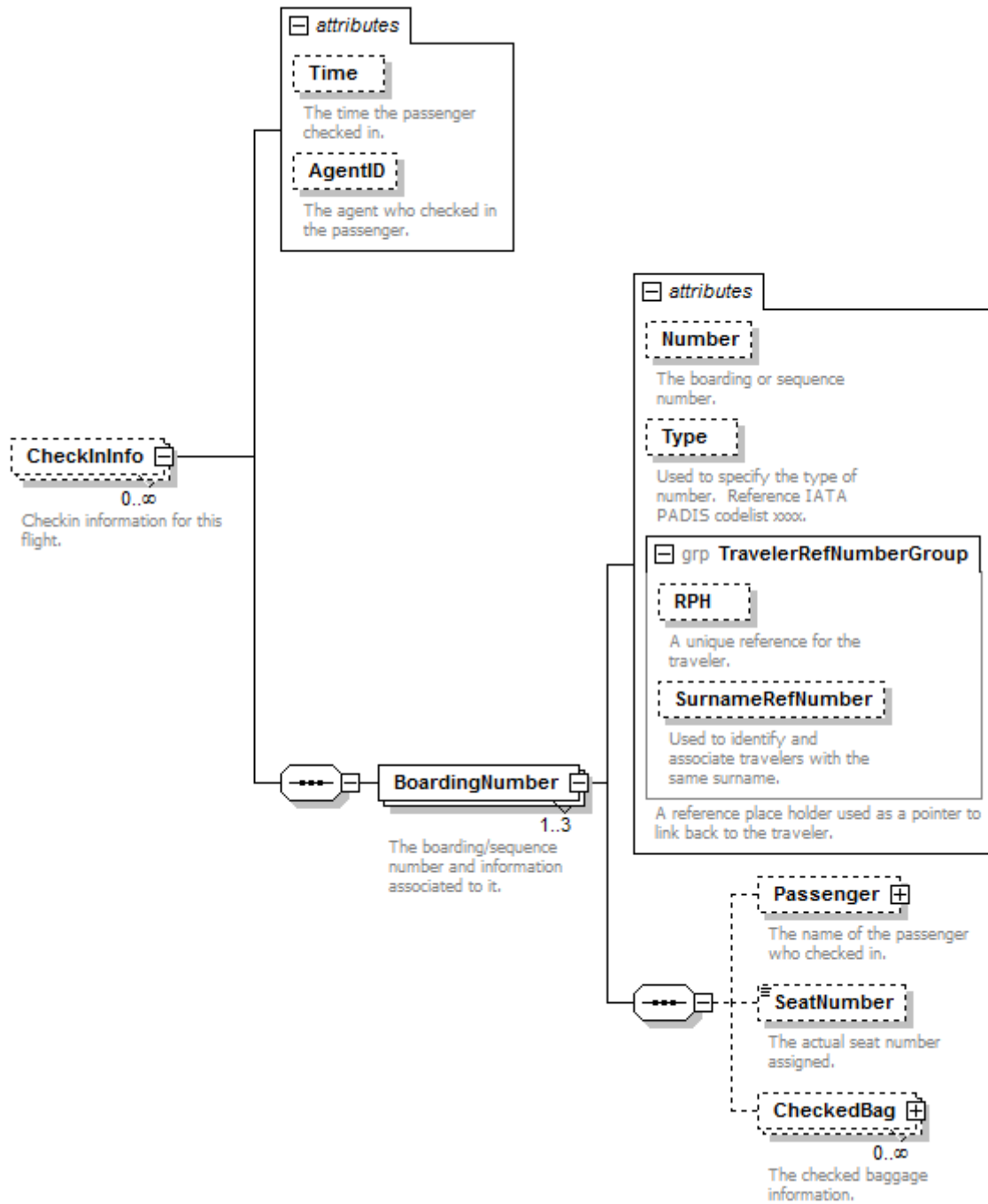

CheckInInfo

Data Item	Type	Max Occurs	Comments
Time	YYYY-MM-DDTHH:MM:SS or YYY-MM-DD or HH:MM:SS	1	The date and/or time the passenger checks in.
AgentID	string	1	The agent who checked in passenger
BoardingNumber/Number	an	1	The boarding or sequence number
BoardingNumber/Type	IATA_CodeType	1	Used to specify the type of number either boarding or check-in
BoardingNumber/RPH	string	1	
BoardingNumber/ SurnameRefNumber	string	1	Identifies and associates travellers with the same surname.

Example:

```
<CheckInInfo AgentID="131312" Time="2013-05-27T13:00:00">
  <BoardingNumber Number="5">
```

4.33 Passenger – the checked-in name

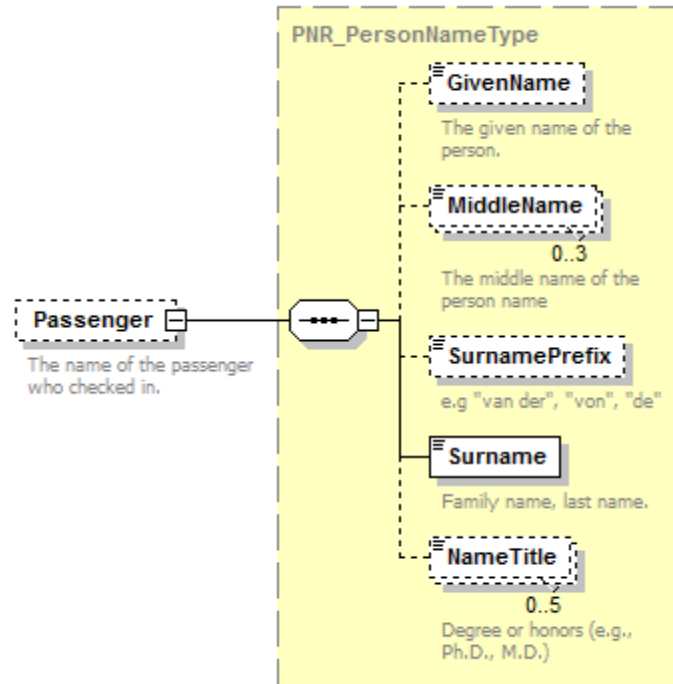

Passenger

Data Item	Type	Max Occurs	Comments
GivenName	string	1	Give name or first name of the passenger.
MiddleName	string	3	Middle name of the passenger.
SurnamePrefix	string	1	Prefix for the surname of the passenger.
Surname	string	1	Family or last name of the passenger.
NameTitle	string	5	Title for the passenger.

Example:

```

<Passenger>
  <GivenName>KEVINMICHAELMR</GivenName>
  <Surname>DENBERG</Surname>
</Passenger>

```

4.34 SeatNumber – actual seat number

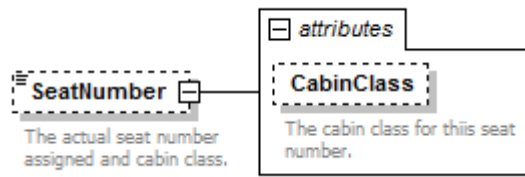

SeatNumber

Data Item	Type	Max Occurs	Comments
SeatNumber	an	1	The actual seat number assigned to the passenger.
CabinClass	a	1	The cabin class for this seat number.

Example:

```
<SeatNumber CabinClass="Y">23</SeatNumber>
```

4.35 CheckedBag – checked bag information

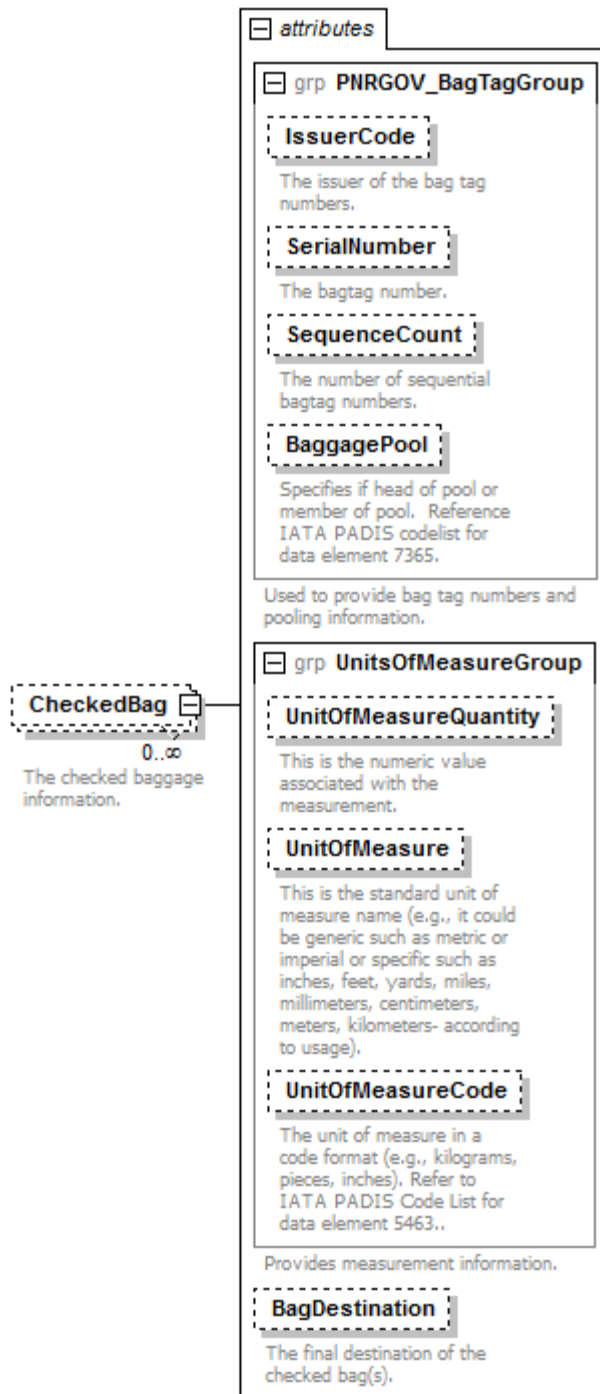

CheckedBag

Data Item	Type	Max Occurs	Comments
IssuerCode	an	1	The issuer of the bag tag number.
SerialNumber	string	1	The bag tag number.
SequenceCount	n	1	The number of sequential bag tag numbers.
BaggagePool	IATA_CodeType	1	Specifies if head of pool or member of pool
UnitOfMeasureQuantity	n	1	The weight or number of pieces of checked baggage.
UnitOfMeasure		N/A	
UnitOfMeasureCode	IATA_CodeType	1	To specify if the actual number of pieces or total weight of baggage.
BaggageDestination	AN	1	The final destination of the bag.

Example:

```
<CheckedBag IssuerCode="SQ" SerialNumber="0012313122" SequenceCount="1" BaggagePool="MP"/>
```

4.36 SplitPNR – the number of passengers split to/from a passenger record and the split record locators

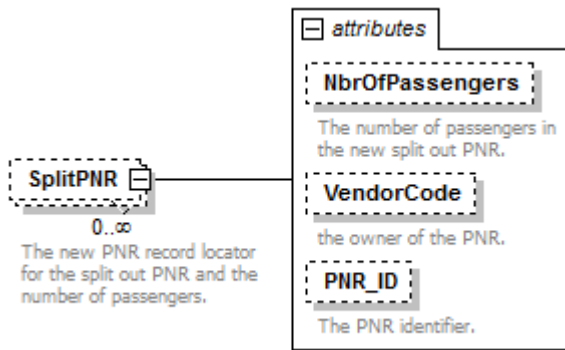

SplitPNR

Data Item	Type	Max Occurs	Comments
NbrOfPassengers	n	1	Number of passengers in the new split out PNR
VendorCode	an	1	The owner of the PNR.
PNR_ID	an	1	The PNR identifier.

Example:

`<SplitPNR NbrOfPassengers="1" VendorCode="SG" PNR_ID="YASDAS"/>`

4.37 OtherTravelSegment – non- air segment information (car, hotel)

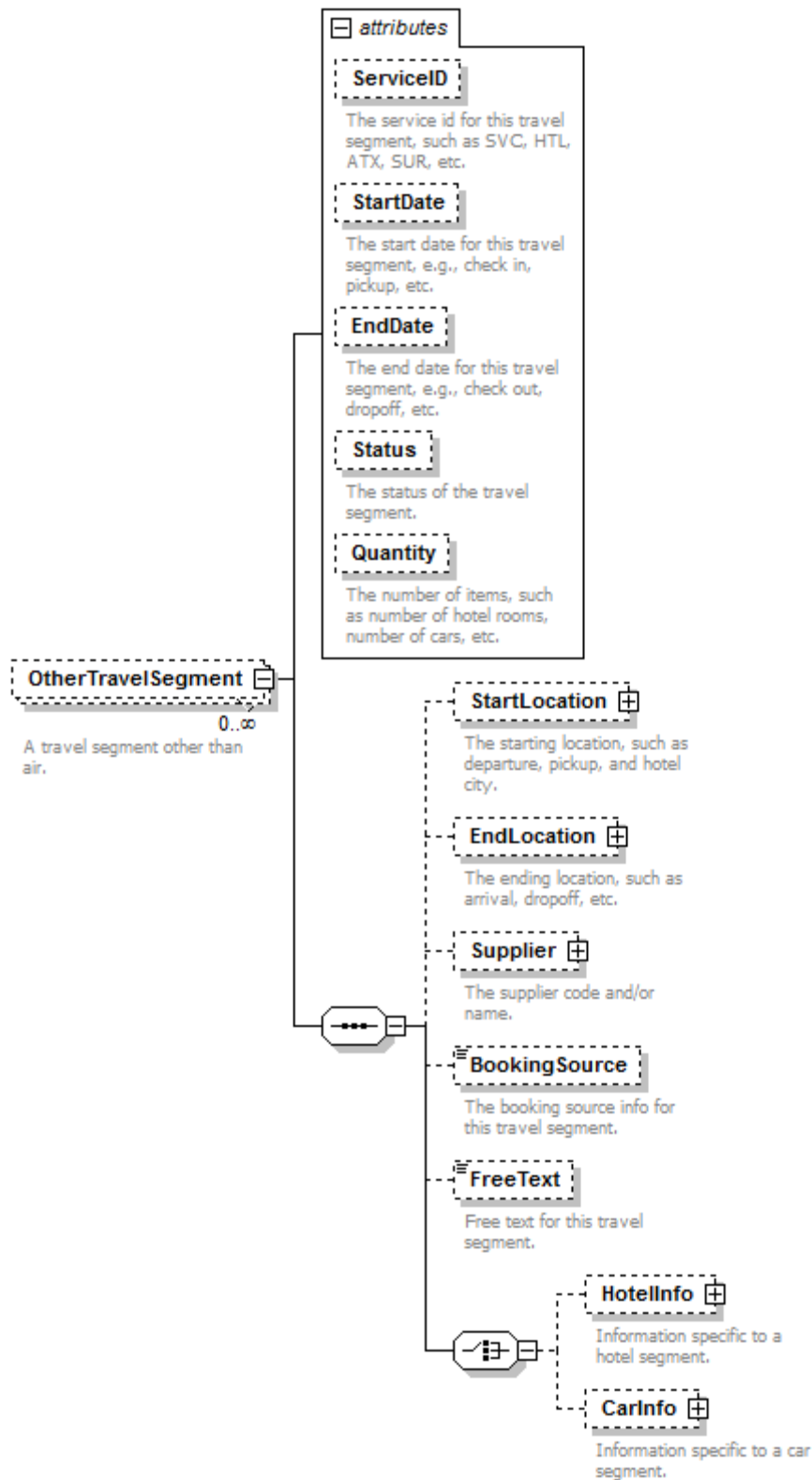

OtherTravelSegment

Data Item	Type	Max Occurs	Comments
ServiceID	IATA_CodeType	1	Identifies the type of travel segment. i.e. SVC, HTL, etc.
StartDate	YYYY-MM-DD	1	Start date for this travel segment
EndDate	YYYY-MM-DD	1	End date for this travel segment
Status	string	1	The status of the travel segment.
Quantity	n	1	The number of items
StartLocation /LocationCode	string	1	The starting location such as departure/pick up
StartLocation /CodeContext		N/A	
EndLocation /LocationCode	string	1	The ending location such as drop off location.
EndLocation /CodeContext		N/A	
Supplier / CompanyShortName	string	1	The name of the company supplier providing the service.
Supplier /TravelSector	IATA_CodeType	1	Specifies the type of supplier.
Supplier /Code	an	1	A code identifying the supplier.
Supplier /CodeContext		N/A	
BookingSource	string	1	Booking source info for this travel segment.
FreeText	string	1	Free text for this travel segment

Example:

```
<OtherTravelSegment ServiceID="HTL" StartDate="2013-05-27" EndDate="2013-05-30" Quantity="1">
  <StartLocation LocationCode="ICN"/>
```

4.38 HotelInfo – hotel segment data

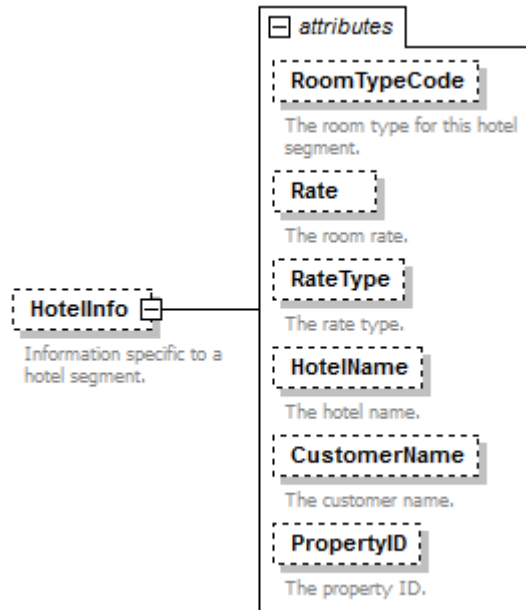

HotelInfo

Data Item	Type	Max Occurs	Comments
RoomTypeCode	string	1	Room type for this hotel.
Rate	decimal	1	Room rate
RateType	string	1	Rate type
HotelName	string	1	Name of hotel
CustomerName	string	1	Customer name
PropertyID	an	1	Property ID number

Example:

```
<HotelInfo CustomerName="Kevin Von Denberg" HotelName="Hilton" PropertyID="14234" Rate="150.00"/>
```

4.39 CarInfo – car segment information

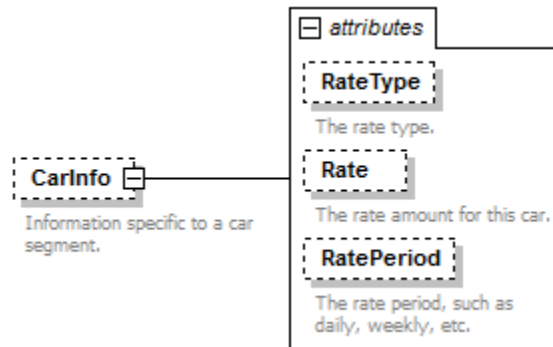

CarInfo

Data Item	Type	Max Occurs	Comments
RateType	string	1	Car rate type
Rate	decimal	1	Cost of this car
RatePeriod	an	1	Period of rental

Example:

`<CarInfo RateType="USD" Rate="100" RatePeriod="WKY"/>`

4.40 StructuredPNR_History – structured PNR history (repeats for each occurrence of a history credit).

Note: Includes the originator of the change, agent ID, and a time stamp.

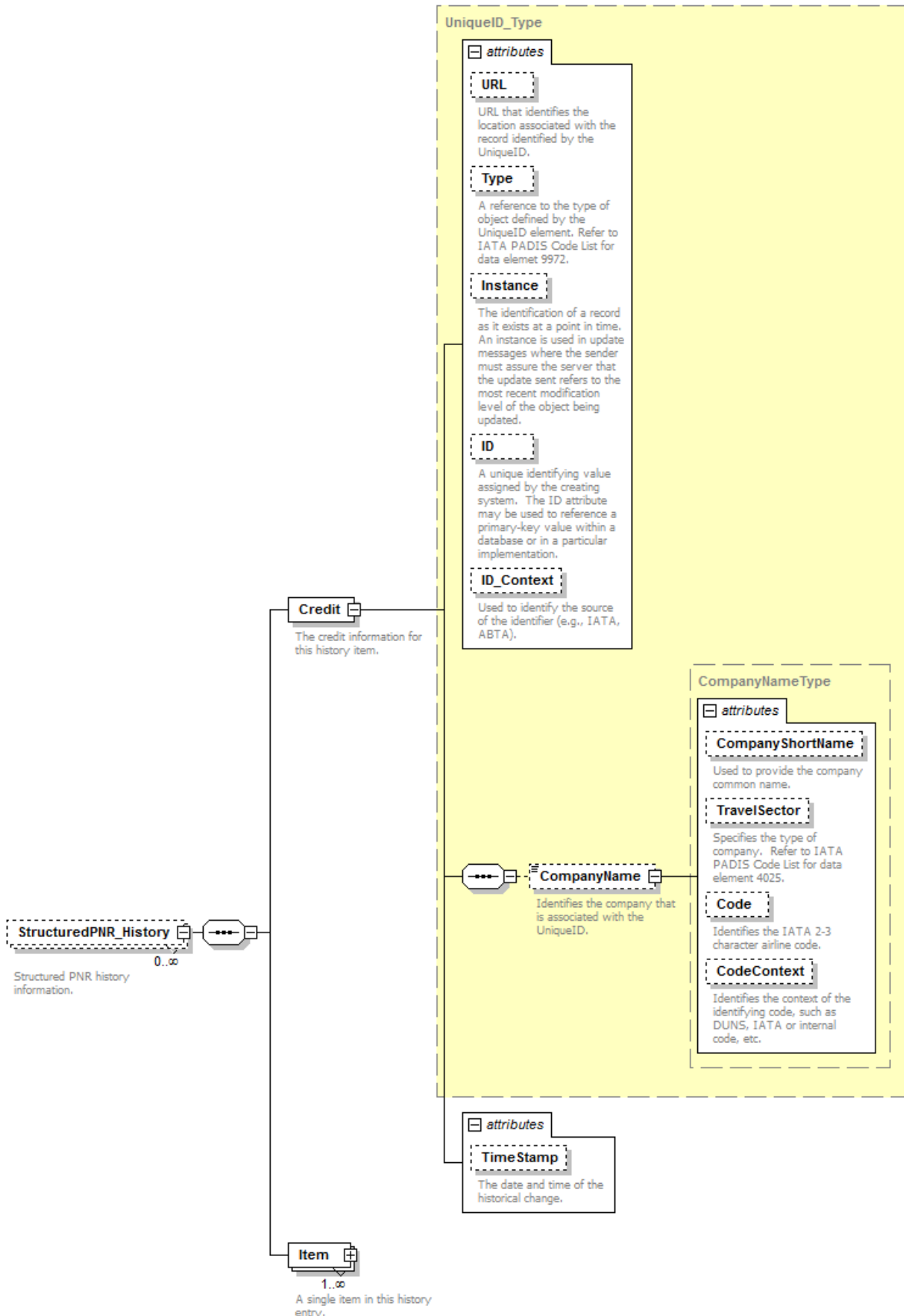

CreditInfo

Data Item	Type	Max Occurs	Comments
URL		N/A	
Type	IATA_CodeType	1	Code identifying type of credit.
Instance		N/A	
ID	string	1	Identifies who made the change
ID_Context		N/A	
CompanyName/ CompanyShortName		N/A	
CompanyName/ TravelSector		N/A	
CompanyName/Code	an	1	2-3 code for airline/CRS company name.
CompanyName/ CodeContext		N/A	
TimeStamp	YYYY-MM-DDTHH:MM:SS or YYYY-MM_DD	1	The date and/or time of the historical change.

Example:

```

<StructuredPNR_History>
  <Credit Type="4" TimeStamp="2013-05-13T18:13:00">
    <CompanyName Code="TZ"/>
  </Credit>

```

4.41 Item – one line in a history credit

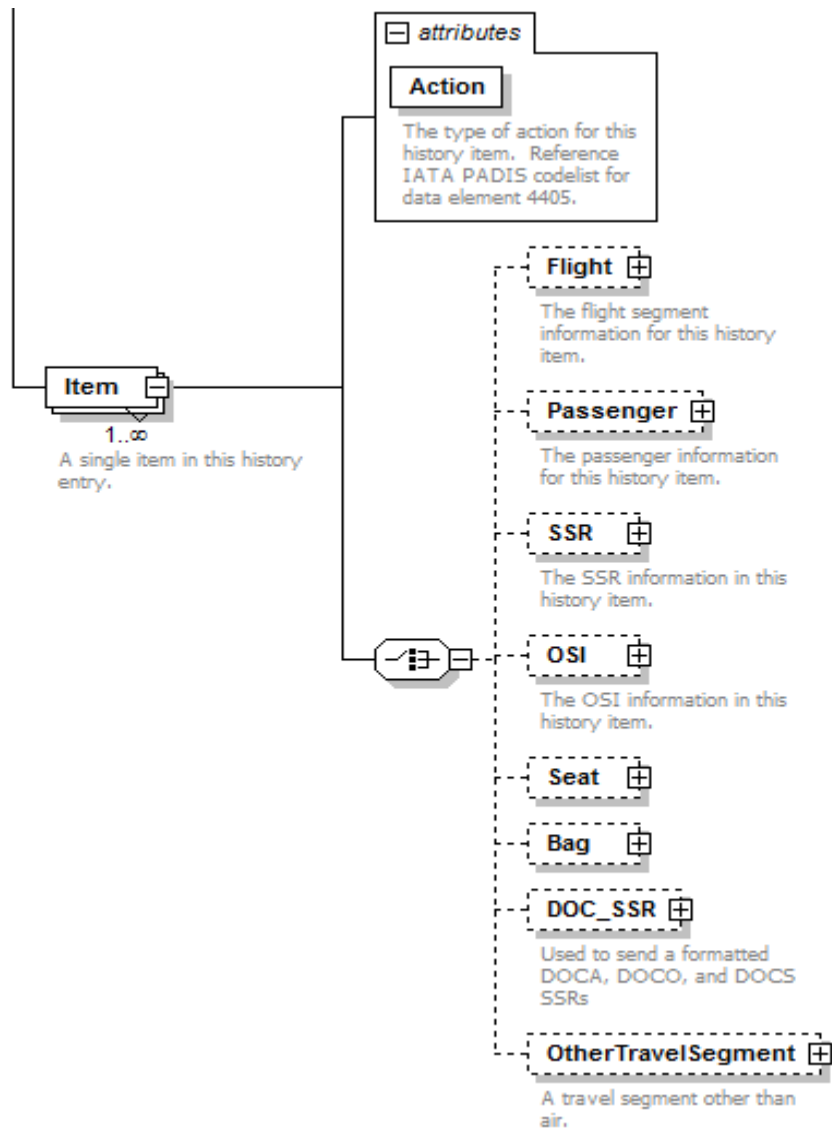

Item

Data Item	Type	Max Occurs	Comments
Action	IATA_CodeType	1	The type of action – add, delete, change

Example:

<Item Action="X">

4.42 Flight – history flight information

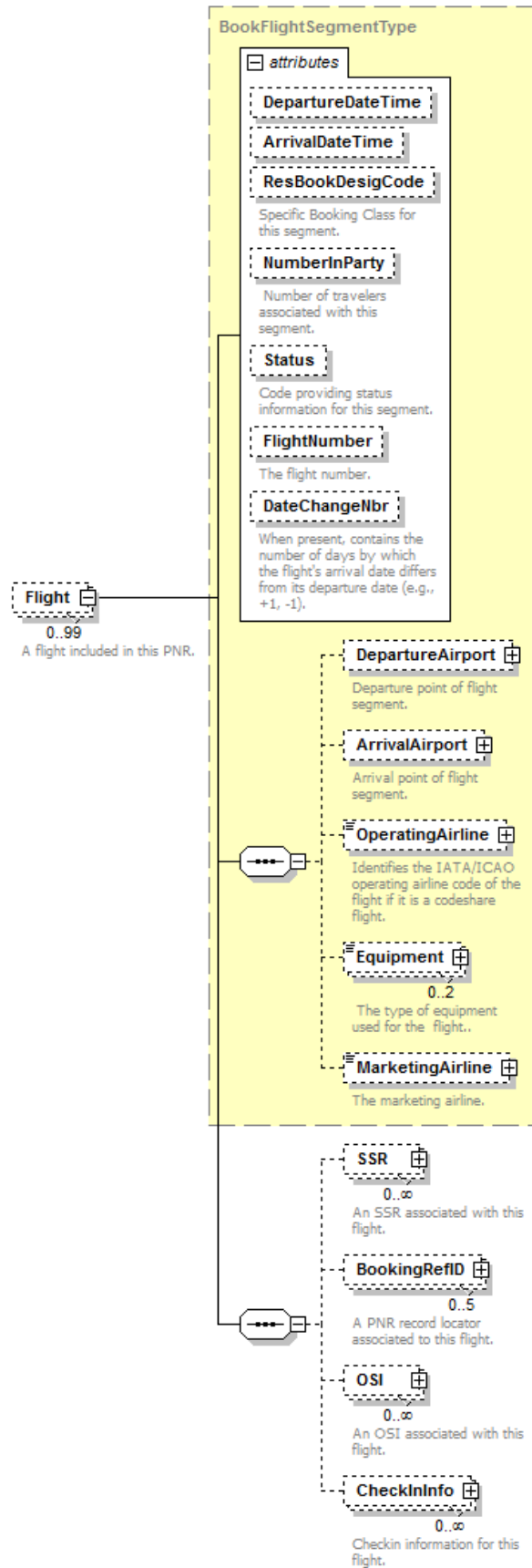

Flight

Data Item	Type	Max Occurs	Comments
DepartureDateTime	YYYY-MM-DDTHH:MM:SS or YYYY-MM_DD or HH:MM:SS	1	The departure date and time of the item.
ArrivalDateTime	YYYY-MM-DDTHH:MM:SS or YYYY-MM_DD or HH:MM:SS	1	The arrival date and time of the item.
ResBookDesigCode	a	1	Reservation booking airline code when it differs from the operating code.
NumberInParty	integer	1	Number of travellers associated with this item.
Status	an..3	1	The status of this flight.
FlightNumber	an	1	The flight number associated with this flight.
DateChangeNbr	string	1	The number of days between the arrival date and departure date.
DepartureAirport/ LocationCode	string	1	The IATA city code for the departure airport.
DepartureAirport/ CodeContext		N/A	
ArrivalAirport/ LocationCode	string	1	The IATA city code for the arrival airport
ArrivalAirport/ CodeContext		N/A	
OperatingAirline/ CompanyShortName		N/A	
OperatingAirline/ TravelSector		N/A	
OperatingAirline/ Code	an	1	IATA 3-2 letter airline code
OperatingAirline/ CodeContext		N/A	
OperatingAirline/ FlightNumber	n..4	1	The flight number of the operating carrier
OperatingAirline/ ResBookDesigCode	an	1	Specific booking class of the operating carrier
Equipment/ AirEquipType	an	1	3 character IATA code for aircraft type
Equipment/ ChangeOfGauge		N/A	
MarketingAirline/ CompanyShortName		N/A	
MarketingAirline/ TravelSector		N/A	
MarketingAirline/ Code	an	1	The marketing airline code.
MarketingAirline/ CodeContext		N/A	

Example:

```

<Flight DepartureDateTime="2013-05-28T00:00:00" ArrivalDateTime="2013-05-29T00:00:00"
ResBookDesigCode="S"
  NumberInParty="1" Status="XX" FlightNumber="6">
  <DepartureAirport LocationCode="SIN"/>
  <ArrivalAirport LocationCode="OOL"/>
  <MarketingAirline Code="TZ"/>
</Flight>
  
```

4.43 Passenger – history passenger name changes

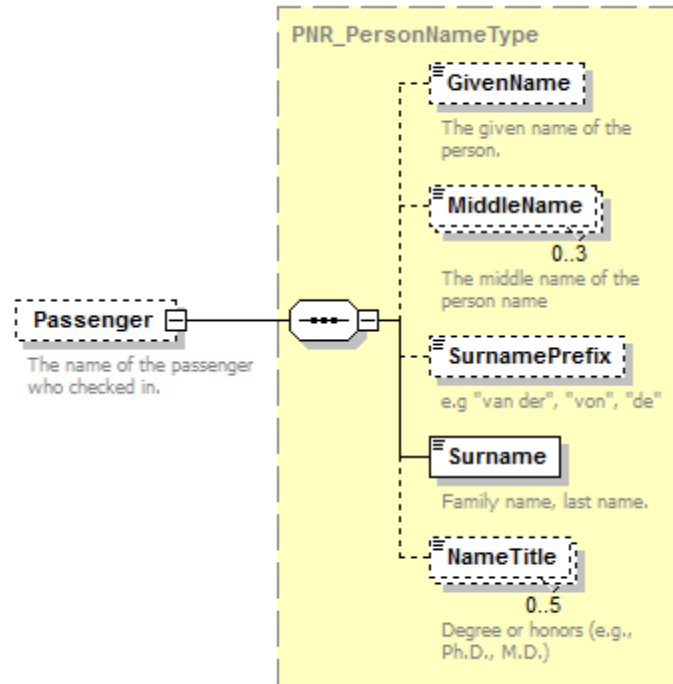

Passenger

Data Item	Type	Max Occurs	Comments
GivenName	string	1	The given name of the passenger.
MiddleName	string	3	The middle name of the passenger.
SurnamePrefix	string	1	The surname prefix of the passenger.
Surname/	string	1	The surname of the passenger.
NameTitle	string	5	The title of the passenger.

Example:

```
<Passenger SurnameRefNumber="1">
  <GivenName>SEJOON</GivenName>
  <Surname>PARK</Surname>
</Passenger>
```

4.44 SSR – history special service requirement changes

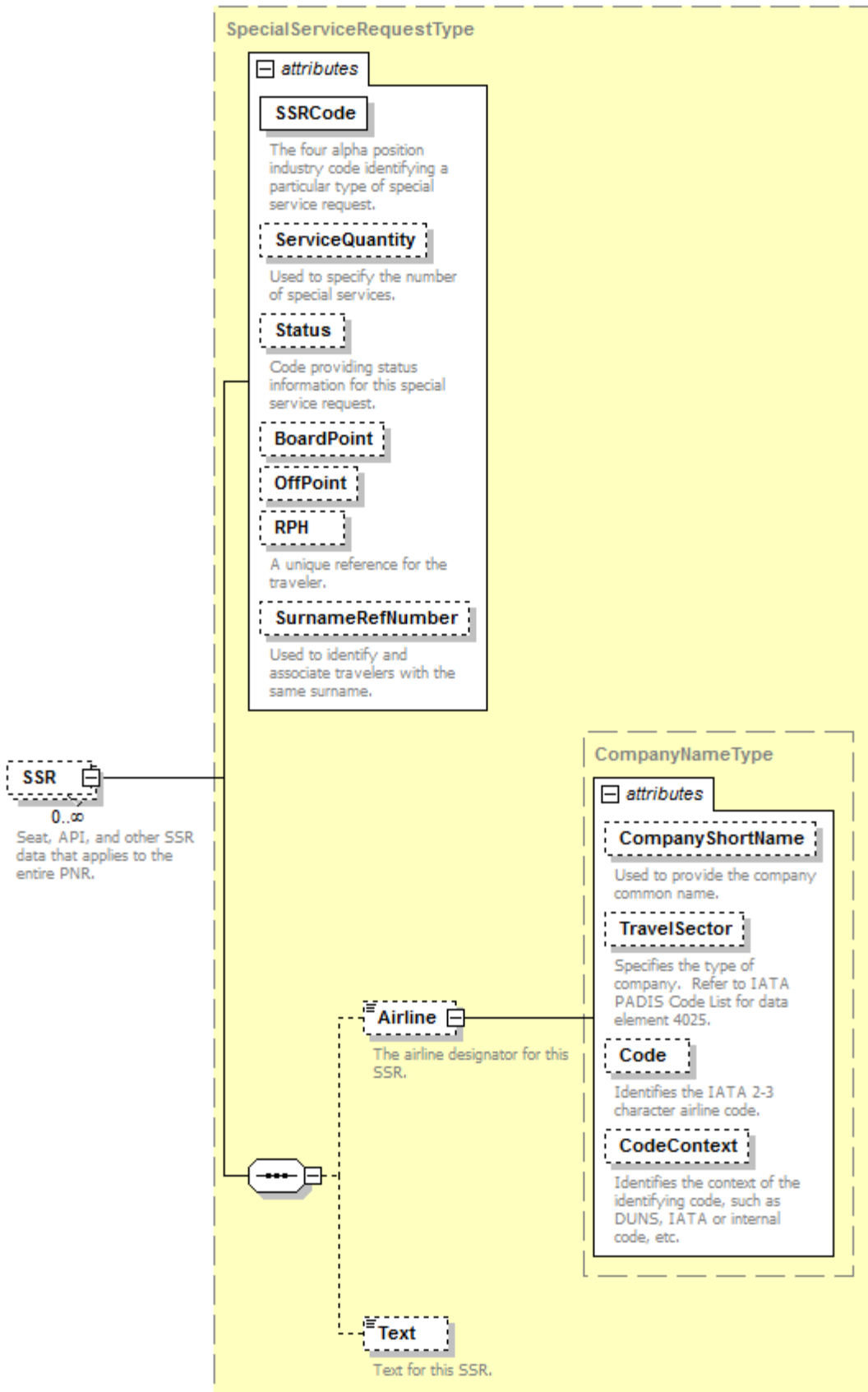

SSR

Data Item	Type	Max Occurs	Comments
SSRCode	a4	1	The industry code identifying a particular type of service request.
ServiceQuantity	n..2	1	Specifies the number of special services.
Status	a..2	1	Status for this special service request.
BoardPoint	an..5	1	The board city of the segment to which special service request applies.
OffPoint	an..5	1	The off city of the segment to which special service request applies.
RPH	string	1	A unique reference for this SSR
SurnameRefNumber	string	1	Used to identify and associate travellers with the same surname.
Airline/ CompanyShortName		N/A	
Airline/ TravelSector		N/A	
Airline/ Code	string	1	Airline code identifying the system to which special service applies.
Airline/ CodeContext		N/A	
Text	string	1	Text for this SSR.

Example:

```

<SSR SSRCode="CKIN" ServiceQuantity="1" Status="HK" BoardPoint="ICN" OffPoint="SIN"
SurnameRefNumber="1">
  <Airline Code="SQ"/>
  <Text>10KG EXBG WAIVER AUTH BY MDPRM</Text>
</SSR>
  
```

4.45 OSI – history other service information changes

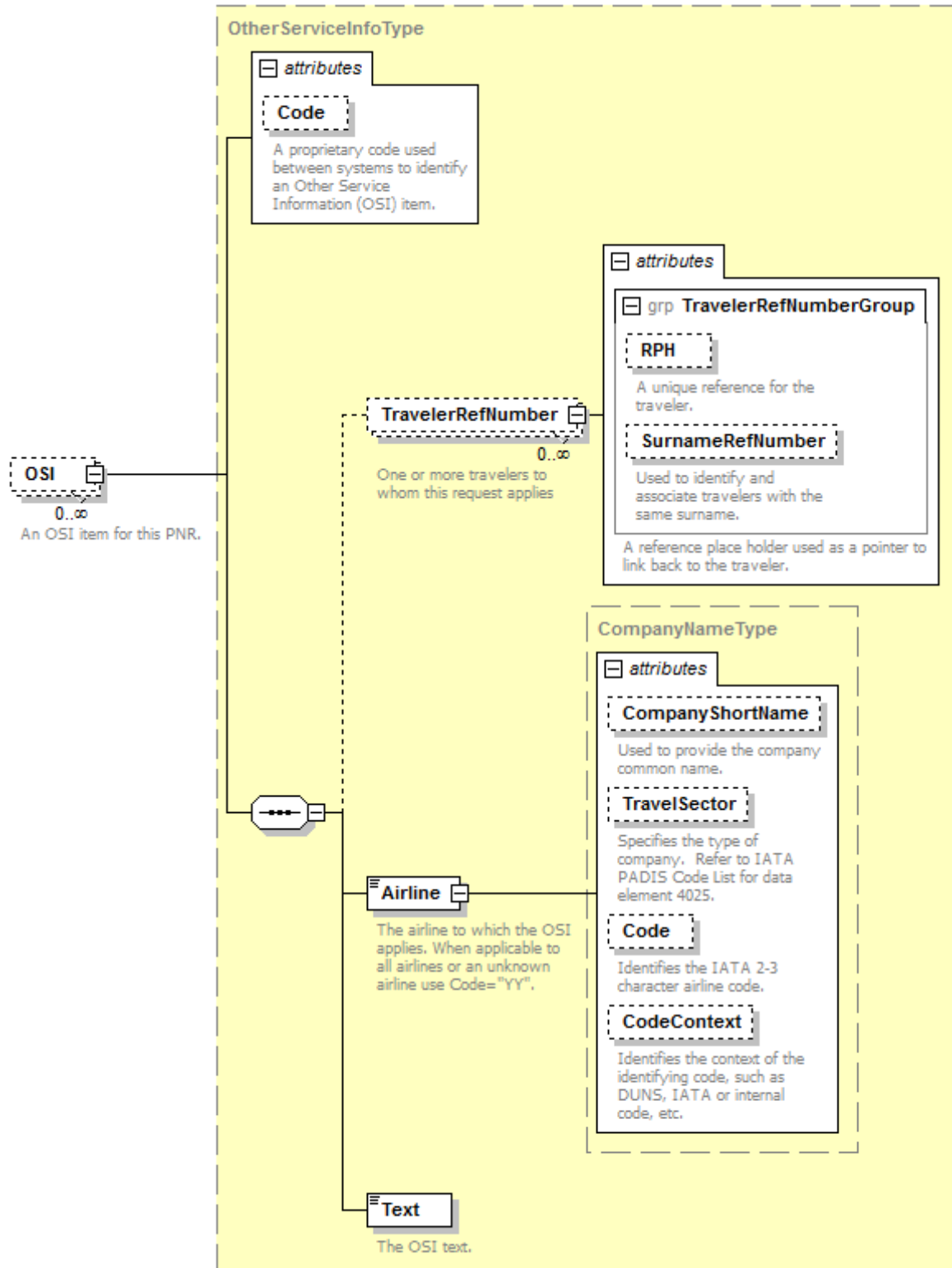

OSI

Data Item	Type	Max Occurs	Comments
Code	an..4	1	A proprietary code used between systems to identify other service information (OSI) item.
TravellerRefNumber/RPH	string	1	A unique reference for the traveller
TravellerRefNumber/SurnameRefNumber	string	1	Used to identify and associate travellers with the same surname.
Airline/CompanyShortName		N/A	
Airline/TravelSector		N/A	
Airline/Code	string	1	Airline code identifying system to which OSI applies.
Airline/CodeContext		N/A	
Text	string	1	Text for this OSI.

Example:

```

<OSI Code="CTC">
  <TravelerRefNumber RPH="1234234" />
  <Airline Code="TZ"/>
  <Text>7732486972</Text>
</OSI>

```

4.46 Seat – history seat changes

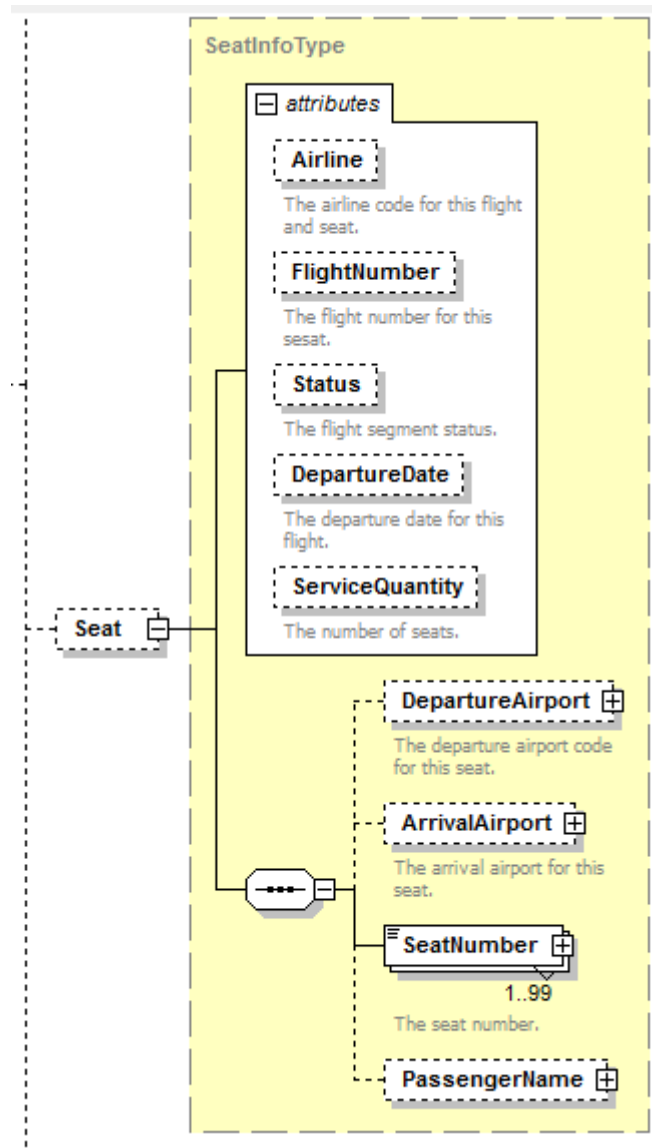

Seat

Data Item	Type	Max Occurs	Comments
Airline		1	
FlightNumber	n	1	Flight number for the passenger
Status	an.	1	Status for the seat
DepartureDate	YYYY-MM-DDTHH:MM:SS or YYYY-MM-DD	1	The departure date and/or time of the service.
ServiceQuantity	n	1	The quantity of the request.
DepartureAirport/LocationCode	an3	1	The IATA city code for the departure airport
DepartureAirport/CodeContext		N/A	
ArrivalAirport/LocationCode	an3	1	The IATA city code for the arrival airport.
ArrivalAirport/CodeContext		N/A	
SeatNumber/PsgrReference	string	1	A unique reference number for the passenger.
SeatNumber/Number	an	1	The seat number assigned to the passenger.
PassengerName/GivenName	string	1	The given/first name of the passenger.
PassengerName/MiddleName	string	3	The middle name of the passenger.
PassengerName/SurnamePrefix	string	1	The surname prefix of the passenger.
PassengerName/Surname	string	1	The surname/family name of the passenger.
PassengerName/NameTitle	string	5	The title of the passenger.

Example:

```

<Seat Airline="DL" DepartureDate="2013-06-30" FlightNumber="352">
  <DepartureAirport Location="ATL"/>
  <Seat Number="22B"?>
</Seat>

```

4.47 Bag – history baggage changes

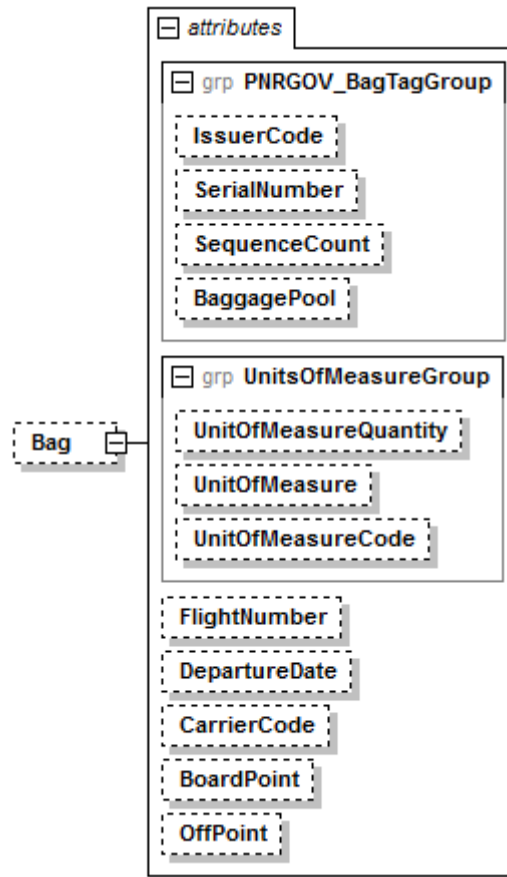

Bag

Data Item	Type	Max Occurs	Comments
IssuerCode	an	1	The issuer of the bag tag number.
SerialNumber	n	1	The bag tag number.
SequenceCount	n	1	The number of sequential bag tags.
BaggagePool	IATA_CodeType	1	Specifies if head of pool or member of pool
UnitOfMeasureQuantity	n	1	Weight or number of pieces.
UnitOfMeasure		N/A	
UnitOfMeasureCode	IATA_CodeType	1	Used to specify if a number of pieces or total weight.
FlightNumber	n	1	Flight number
DepartureDate	YYYY-MM-DD	1	Departure date
CarrierCode	an	1	Airline code
BoardPoint	an..5	1	IATA Departure point
OffPoint	an..5	1	IATA Arrival point

Example:

```
<Bag IssuerCode="SQ" SerialNumber="0012313122" SequenceCount="1" BaggagePool="MP"
  UnitOfMeasureQuantity="20" UnitOfMeasureCode="700"/>
```

4.48 DOC_SSR – history formatted SSR changes (DOCA, DOCO, DOCS)

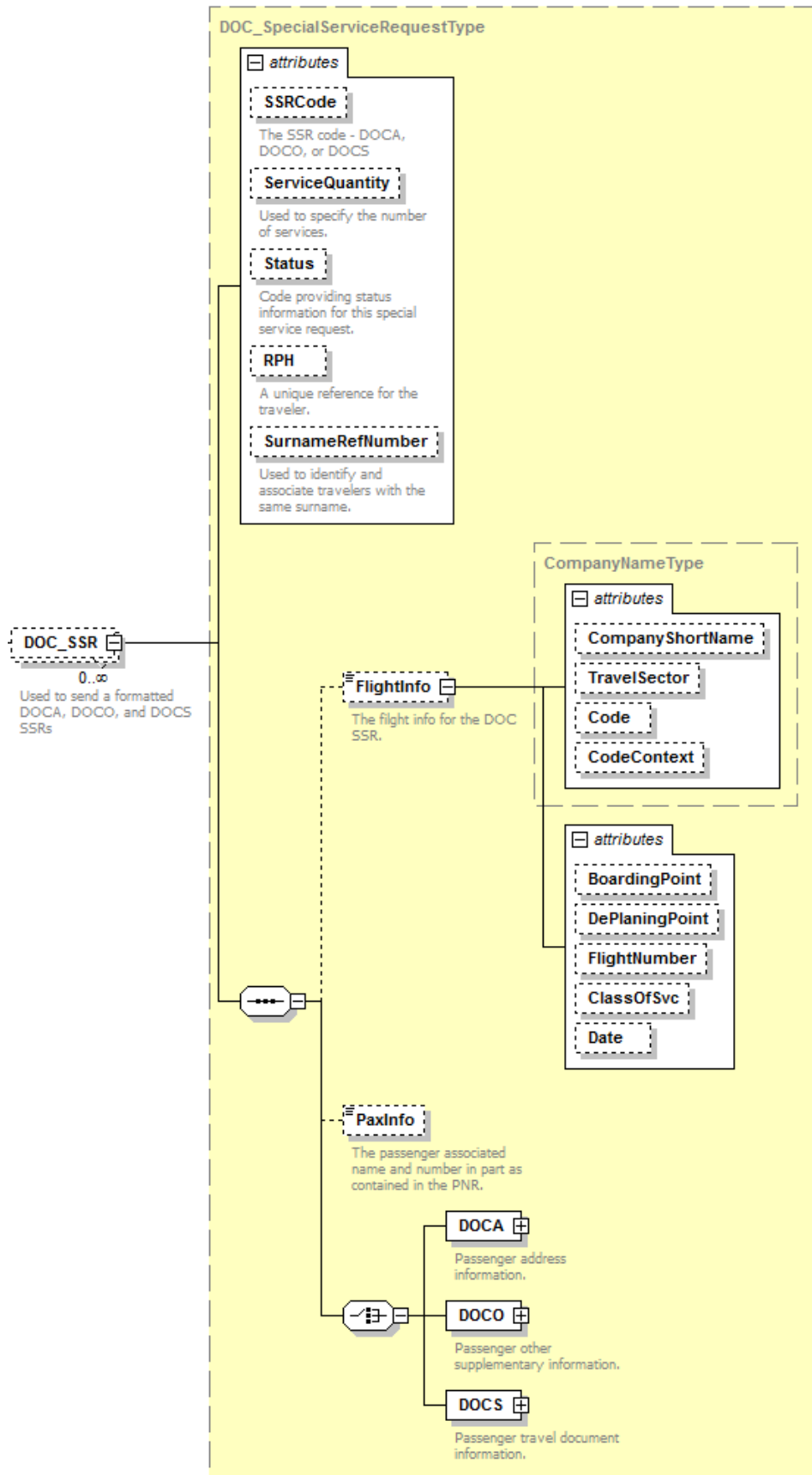

DOC_SSR

Data Item	Type	Max Occurs	Comments
SSRCode	a4	1	Specifies DOCA/DOCO/DOCS
ServiceQuantity	n..2	1	Number of services for SSR
Status	a..2	1	Status information for the SSR
RPH	string	1	A unique reference to the traveller
SurnameRefNbr	string	1	Used to reference a traveller with the same surname
FlightInfo/ CompanyShortName		N/A	
FlightInfo/ TravelSector		N/A	
FlightInfo/ Code	an..3	1	Airline code for this SSR
FlightInfo/ CodeContext		N/A	
FlightInfo/ BoardingPoint	an..5	1	City code where passenger boards this flight.
FlightInfo/ DePlanningPoint	an..5	1	City code where passenger deplanes.
FlightInfo/ FlightNumber	n..4	1	Flight number for this SSR
FlightInfo/ ClassOfSvc	a1	1	Class of service
FlightInfo/ Date	an7	1	Flight date in DDMMYY format
PaxInfo	string	1	Passenger associated name and number in part as contained in the PNR.

Example:

```
<DOC_SSR SSRCode="DOCS" ServiceQuantity="1" Status="HK">
```

4.49 DOCA – history formatted passenger address SSR changes

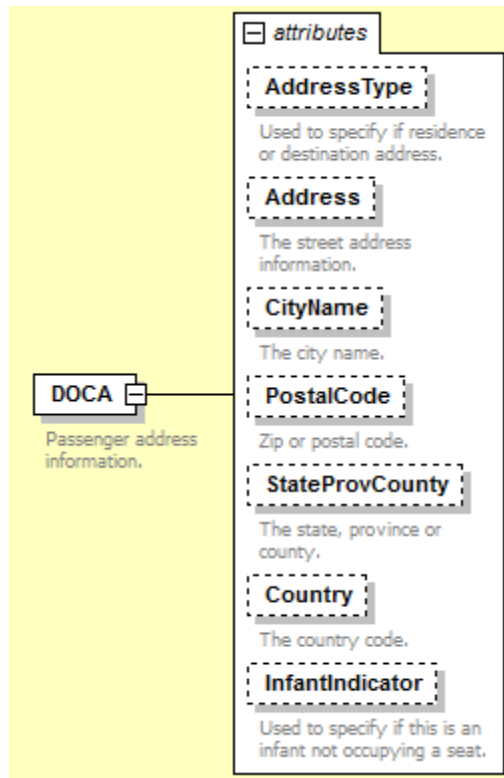

DOCA

Data Item	Type	Max Occurs	Comments
AddressType	a1	1	Used to specify resident or destination.
Address	string	1	Street address information
CityName	an..35	1	City name
PostalCode	an..17	1	Zip or Post code
StateProvCounty	an..35	1	State/Prov/County
Country	an..3	1	Country Code
InfantIndicator	a1	1	Specifies infant not occupying seat.

Example:

```
<DOC_SSR SSRCode="DOCA" ServiceQuantity="1" Status="HK">
  <FlightInfo Code="TZ"/>
  <DOCA AddressType="D" Address="123 Jefferson Ave" CityName="Atlanta" PostalCode="13445"
    StateProvCounty="GA" Country="USA"/>
</DOC_SSR>
```

4.50 DOCO – history formatted passenger other supplementary information SSR changes

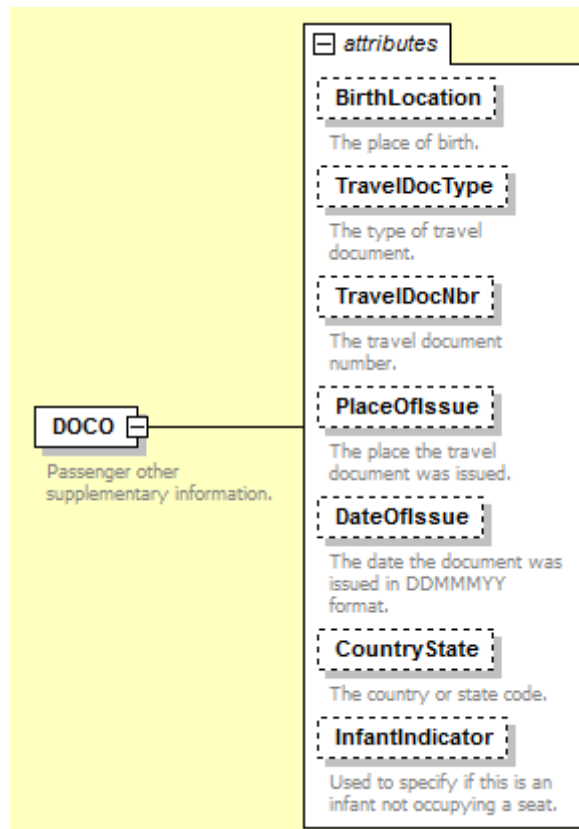

DOCO

Data Item	Type	Max Occurs	Comments
BirthLocation	an..35	1	Place of birth
TravelDocType	a1	1	Type of travel document
TravelDocNbr	an..25	1	Travel document number
PlaceOfIssue	an..35	1	Place travel document issued
DateOfIssue	an7	1	Date document issued in DDMMYY format
CountryState	an..3	1	Country/State code
InfantIndicator	a1	1	Specified this is an infant not occupying a seat

Example:

```
<DOC_SSR SSRCode="DOCO" ServiceQuantity="1" Status="HK">
  <DOCO BirthLocation="USA" TravelDocType="V" TravelDocNbr="1214213" PlaceOfIssue="CAN"
    DateOfIssue="02FEB12" CountryState="CAN"/>
</DOC_SSR>
```

4.51 DOCS – history formatted passenger travel document SSR changes

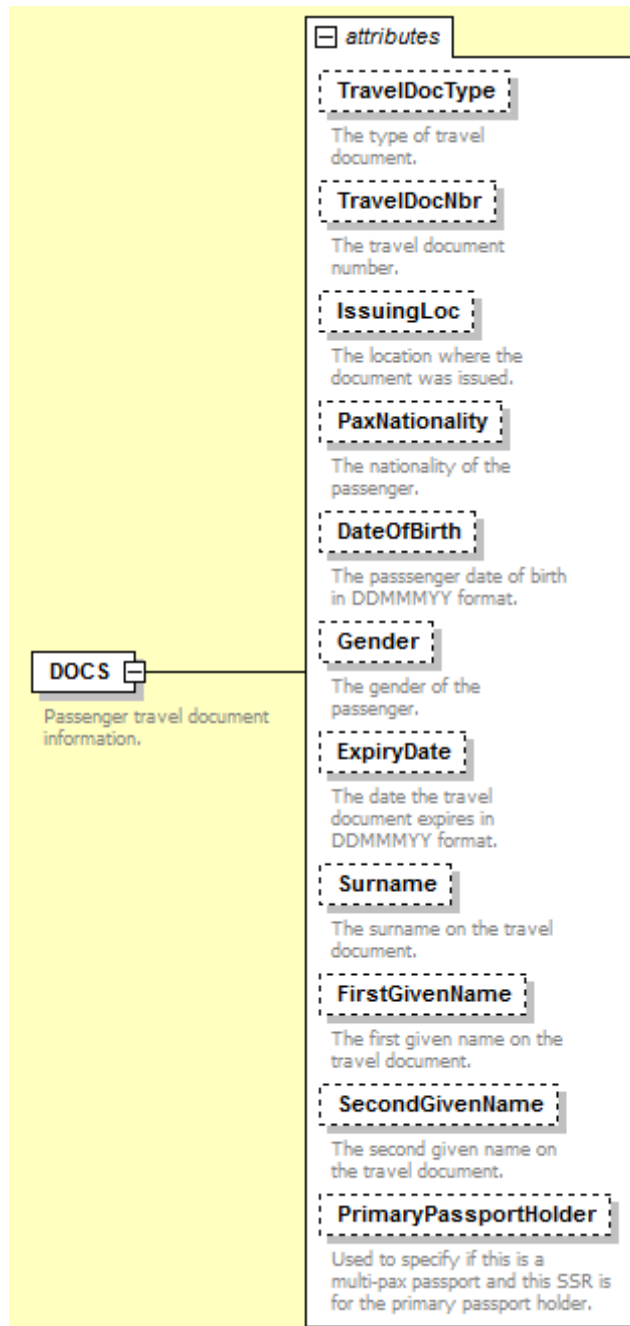

DOCS

Data Item	Type	Max Occurs	Comments
TravelDocType	an..2	1	Type of travel document
TravelDocNbr	an..15	1	Travel document number
IssuingLoc	an..3	1	Location where document issued
PaxNationality	an..3	1	Nationality of passenger
DateOfBirth	an7	1	Date of birth DDMMYY
Gender	a..2	1	Gender of passenger
ExpiryDate	an7	1	Date travel document expires DDMMYY
Surname	string	1	Surname on travel document
FirstGivenName	string	1	First given name on travel document
SecondGivenName	string	1	Second given name on travel document
PrimaryPassportHolder	a1	1	Specifies if this is a multi pax passport and this SSR is for the primary passport holder.

Example:

```

<DOC_SSR SSRCode="DOCS" ServiceQuantity="1" Status="HK">
  <DOCS DateOfBirth="04JUL80" ExpiryDate="12JAN19" FirstGivenName="KEVIN"
    SecondGivenName="MICHAEL" Surname="VON DENBERG" Gender="M" IssuingLoc="USA"
    PaxNationality="USA" TravelDocNbr="548721687" TravelDocType="P"/>
</DOC_SSR>
  
```

4.52 OtherTravelSegment – non- air segment information (car, hotel) changes

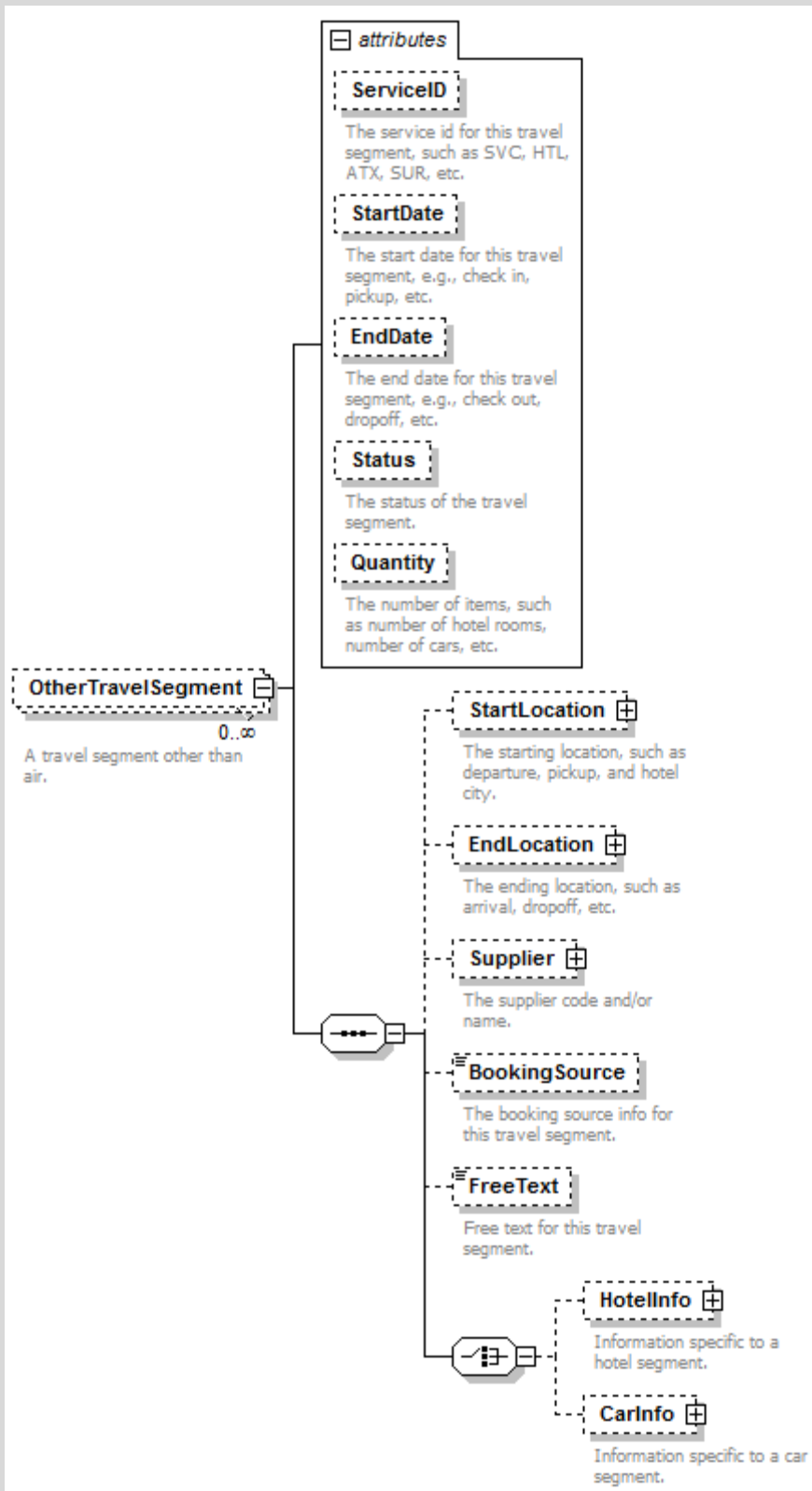

OtherTravelSegment

Data Item	Type	Max Occurs	Comments
ServiceID	IATA_CodeType	1	Identifies the type of travel segment. i.e. SVC, HTL, etc.
StartDate	YYYY-MM-DD	1	Start date for this travel segment
EndDate	YYYY-MM-DD	1	End date for this travel segment
Status	string	1	The status of the travel segment.
Quantity	n	1	The number of items
StartLocation/LocationCode	string	1	The starting location such as departure/pick up
StartLocation/CodeContext		N/A	
EndLocation/LocationCode	string	1	The ending location such as drop off location.
EndLocation/CodeContext		N/A	
Supplier/CompanyShortName	string	1	The name of the company supplier providing the service.
Supplier/TravelSector	IATA_CodeType	1	Specifies the type of supplier.
Supplier/Code	an	1	A code identifying the supplier.
Supplier/CodeContext		N/A	
BookingSource	string	1	Booking source info for this travel segment.
FreeText	string	1	Free text for this travel segment

Example:

```
<OtherTravelSegment ServiceID="HTL" StartDate="2013-05-27" EndDate="2013-05-30" Quantity="1">
  <StartLocation LocationCode="ICN"/>
```

4.53 HotelInfo – hotel segment data

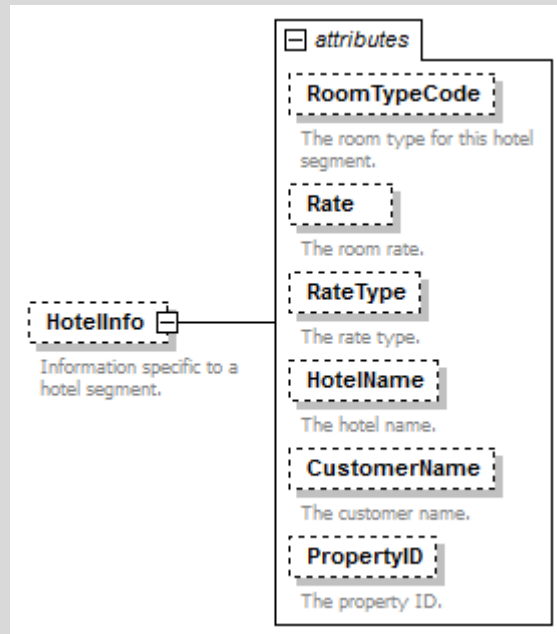

HotelInfo

Data Item	Type	Max Occurs	Comments
RoomTypeCode	string	1	Room type for this hotel.
Rate	decimal	1	Room rate
RateType	string	1	Rate type
HotelName	string	1	Name of hotel
CustomerName	string	1	Customer name
PropertyID	an	1	Property ID number

Example:

```
<HotelInfo CustomerName="Kevin Von Denberg" HotelName="Hilton" PropertyID="14234" Rate="150.00"/>
```

4.54 CarInfo – car segment information

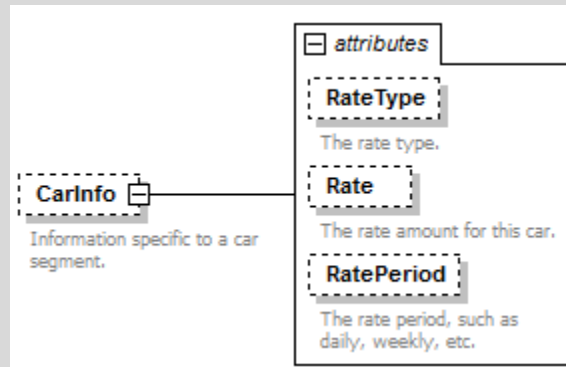

CarInfo

Data Item	Type	Max Occurs	Comments
RateType	string	1	Car rate type
Rate	decimal	1	Cost of this car
RatePeriod	an	1	Period of rental

Example:

```
<CarInfo RateType="USD" Rate="100" RatePeriod="WKY"/>
```

4.55 UnstructuredPNR_History – unformatted history information

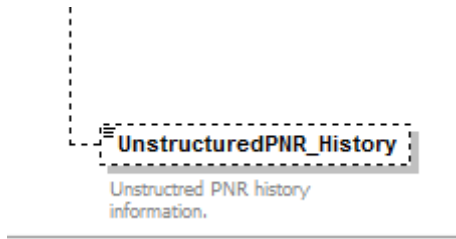

UnstructuredHistory

Data Item	Type	Max Occurs	Comments
UnstructuredHistory	String		Unstructured PNR history information

Example:

<UnstructuredPNR_History>/130513/TZ X 130528/130529/S/1/HK/6/SIN/OOL/TZ</UnstructuredPNR_History>

5 FULL MESSAGE EXAMPLE

```

<IATA_PNRGOV_NotifRQ
  EchoToken="123456" TimeStamp="2013-05-27T07:54:00" Target="Production" Version="1.000"
  TransactionIdentifier="a8431fd0-e8a7-11e2-91e2-0800200c"
    SequenceNmbr="1" TransactionStatusCode="Start" RetransmissionIndicator="false"
  CorrelationID="57ab4200-e8a7-11e2-91e2-0800200c9a66"
    xsi:schemaLocation="http://www.iata.org/IATA/2007/00 IATA_PNR_GOV_NotifRQ.xsd"
    xmlns="http://www.iata.org/IATA/2007/00"
    xmlns:xsi="http://www.w3.org/2001/XMLSchema-instance">
  <Originator AirlineCode="SQ" SystemCode="1A" AirlineContactInfo="1-800-AIR-LINE"/>
  <FlightLeg CarrierCode="SQ" FlightNumber="609" DepartureDateTime="2013-05-27T16:40:00"
  ArrivalDateTime="2013-05-28T22:00:00" DateChangeNbr="+1">
    <DepartureAirport LocationCode="ICN"/>
    <ArrivalAirport LocationCode="SIN"/>
  </FlightLeg>
  <PNRs NumberOfPnrs="1">
    <PNR NumberOfPassengers="2" PNR_TransDate="2013-05-13T21:25:00"
  PNR_CreationDate="2013-05-01" LastTktDate="2013-05-13T21:24:00">
    <BookingRefID ID="W9TEND">
      <CompanyName TravelSector="1" Code="TZ"/>
    </BookingRefID>
    <SSR SSRCode="OTHS" ServiceQuantity="1" Status="HK" BoardPoint="SIN"
  OffPoint="OOL" RPH="1234234">
      <Airline Code="TZ" />
      <Text>ADV TKT NUMBER BY 03MAY13 1800CO OR WILL CANCEL</Text>
    </SSR>
    <OSI Code="CTC">
      <TravelerRefNumber RPH="1234234" />
      <Airline Code="TZ"/>
      <Text>7732486972</Text>
    </OSI>
    <POS>
      <Source AgentSine="HDQKE2400" PseudoCityCode="MUC" ISOCountry="KR"
  ISOCurrency="KRW" AgentDutyCode="3482192" AirlineVendorID="KE" AirportCode="NBE">
        <RequestorID ID="123456789">
          <CompanyName Code="TZ"/>
        </RequestorID>
      </Source>
    </POS>
    <ContactInfo PhoneNumber="5555555" PhoneType="4" EmailAddress="bob@domain.com">
      <StreetNmbr StreetNmbrSuffix="123" StreetDirection="NW"/>
      <AddressLine>ANY STREET</AddressLine>
      <CityName>LAKE TOWN</CityName>
      <PostalCode>55123</PostalCode>
      <StateProv StateCode="MN"/>
      <CountryName Code="US"/>
    </ContactInfo>
    <PrepaidBag UnitOffMeasureQuantity="2" UnitOfMeasureCode="700" Amount="26.00"
  CurrencyCode="CAD" BagDestination="SIN"/>
      <Passenger RPH="1234234" SurnameRefNumber="43576" BoardingStatus="63">
        <GivenName>KEVINMICHAELMR</GivenName>
        <Surname>DENBERG</Surname>
        <CustLoyalty ProgramID="TZ" MembershipID="1234567"/>
        <ExcessBaggage IssuerCode="SQ" SerialNumber="0012313122"
  SequenceCount="1" BaggagePool="MP" UnitOfMeasureQuantity="20" UnitOfMeasureCode="700"/>
          <FareInfo PTC_Code="A" DiscountedFareType="764" DiscountPercent="5"
  CountryCode="US" DiscFareClassType="B2" FareBasis="SFLY"/>
            <SSR SSRCode="NSSA" ServiceQuantity="1" Status="HN" BoardPoint="ICN"
  OffPoint="SIN" RPH="1234234" SurnameRefNumber="1">
              <Airline Code="SQ"/>
              <Text>MADDOX/MOLLY</Text>
            </SSR>
          </Passenger>
        </PrepaidBag>
      </ContactInfo>
    </PNR>
  </PNRs>
</IATA_PNRGOV_NotifRQ>

```

```

    </SSR>
    <TicketDocument TicketDocumentNbr="121341212311" Type="1"
DateOfIssue="2013-05-13" TicketLocation="SIN" PrimaryDocInd="true">
      <TotalFare Amount="1999.99" CurrencyCode="SGD"/>
      <PricingInfo Date="2013-05-01" Time="12:15:00" ISOCountryCode="CN"
LocationCode="S1N" NonEndorsableInd="true" NonRefundableInd="true"
      PenaltyRestrictionInd="true"/>
      <Taxes>
        <Tax Amount="99.99" ISOCountry="CN" CurrencyCode="SGD"
          TaxType="BK"/>
        <Tax Amount="99.99" ISOCountry="CN" CurrencyCode="SGD"
          TaxType="OO"/>
        <Tax Amount="99.99" ISOCountry="CN" CurrencyCode="SGD"
          TaxType="YY"/>
      </Taxes>
      <PaymentInfo PaymentType="CC" PaymentUse="NEW"
PaymentAmount="999.00" VendorCode="MC" ccountNbr="*****1344" ExpiryDate="1214"
CardHolderName="KEVIN MICHAEL VON DENBERG"/>
      </TicketDocument>
      <DOC_SSR SSRCode="DOCA" ServiceQuantity="1" Status="HK">
        <FlightInfo Code="TZ"/>
        <DOCA AddressType="D" Address="123 Jefferson Ave" CityName="Atlanta"
PostalCode="13445" StateProvCounty="GA" Country="USA"/>
      </DOC_SSR>
      <DOC_SSR SSRCode="DOCO" ServiceQuantity="1" Status="HK">
        <DOCO BirthLocation="USA" TravelDocType="V" TravelDocNbr="1214213"
PlaceOfIssue="CAN" DateOfIssue="02FEB12" CountryState="CAN"/>
      </DOC_SSR>
      <DOC_SSR SSRCode="DOCS" ServiceQuantity="1" Status="HK">
        <DOCS DateOfBirth="04JUL80" ExpiryDate="12JAN19"
FirstGivenName="KEVIN" SecondGivenName="MICHAEL" Surname="VON DENBERG"
          Gender="M" IssuingLoc="USA" PaxNationality="USA"
TravelDocNbr="548721687" TravelDocType="P"/>
      </DOC_SSR>
    </Passenger>
    <Flight DepartureDateTime="2013-05-31T22:25:00" ArrivalDateTime="2013-05-29T07:50:00"
ResBookDesigCode="S" NumberInParty="1" Status="HK"
      FlightNumber="6">
      <DepartureAirport LocationCode="SIN"/>
      <ArrivalAirport LocationCode="OOL"/>
      <OperatingAirline Code="SQ" FlightNumber="4523" ResBookDesigCode="S"/>
      <MarketingAirline Code="TX"/>
      <CheckInInfo AgentID="131312" Time="2013-05-27T13:00:00">
        <BoardingNumber Number="5">
          <Passenger>
            <GivenName>KEVINMICHAELMR</GivenName>
            <Surname>DENBERG</Surname>
          </Passenger>
          <SeatNumber CabinClass="Y">23</SeatNumber>
          <CheckedBag IssuerCode="SQ" SerialNumber="0012313122"
SequenceCount="1" BaggagePool="MP"/>
        </BoardingNumber>
      </CheckInInfo>
    </Flight>
    <SplitPNR NbrOfPassengers="1" VendorCode="SG" PNR_ID="YASDAS"/>
    <OtherTravelSegment ServiceID="HTL" StartDate="2013-05-27" EndDate="2013-05-30"
Quantity="1">
      <StartLocation LocationCode="ICN"/>
      <HotelInfo
        CustomerName="Kevin Von Denberg" HotelName="Hilton"
PropertyID="14234" Rate="150.00"/>
    </OtherTravelSegment>
  
```

```

Quantity="1">
  <OtherTravelSegment ServiceID="CAR" StartDate="2013-05-27" EndDate="2013-05-30"
    <StartLocation LocationCode="ICN"/>
    <EndLocation LocationCode="iICN"/>
    <CarInfo RateType="USD" Rate="100" RatePeriod="WKY"/>
  </OtherTravelSegment>
  <StructuredPNR_History>
    <Credit Type="4" TimeStamp="2013-05-13T18:13:00">
      <CompanyName Code="TZ"/>
    </Credit>
    <Item Action="X">
      <Flight DepartureDateTime="2013-05-28T00:00:00" ArrivalDateTime="2013-
05-29T00:00:00" ResBookDesigCode="S" NumberInParty="1"
        Status="XX" FlightNumber="6">
          <DepartureAirport LocationCode="SIN"/>
          <ArrivalAirport LocationCode="OOL"/>
          <MarketingAirline Code="TZ"/>
        </Flight>
      </Item>
    </StructuredPNR_History>
    <UnstructuredPNR_History>
      4/130513/TZ X 130528/130529/S/1/HK/6/SIN/OOL/TZ
    </UnstructuredPNR_History>
  </PNR>
</PNRs>
</IATA_PNRGOV_NotifRQ>

```